

CorkSport Performance

AXO-6-112 Downpipe

Installation Instructions for the CorkSport Performance Downpipe for the 2021+ Mazda 3/CX30
and 2023+ Mazda CX50, 2.5L Turbo.

Written By: Quintin Gunn



INTRODUCTION

In this installation guide we have provided step by step instructions to remove the OEM downpipe and install the CorkSport Performance Turbo Downpipe.

Advisory:

- Working under the vehicle requires a safe and sturdy location for the vehicle to sit on jackstands.
- The engine bay will be hot after recent vehicle operation. Allow the vehicle to cool or use a fan to cool the engine bay before working on the vehicle.

- **Downpipe for off-road and race use only.**

TOOLS:

- 10mm Wrench (1)
- 12mm Wrench (1)
- 14mm Wrench (1)
- 17mm Wrench (1)
- 22mm wrench (1)
- 10mm Socket (1)
- 12mm Socket (1)
- 14mm Socket - Deep (1)
- 17mm Socket - Deep (1)
- 3/8" Ratchet (1)
- 3/8" Extension (1)
- O2/Oxygen Sensor Socket (1)
- 3/8" Torque Wrench (1)
- Flathead Screwdriver (1)
- Hydraulic Jack (1)
- Jack Stand (2)
- Exhaust Hanger Pliers (1)
- Glass Cleaner (1)
- Anti-Seize (1)

PARTS:

- CorkSport Mazda3/CX30/CX50 2.5T Downpipe (1)
- CorkSport SkyActiv 2.5T Bellmouth (1)
- CorkSport SkyActiv 2.5T DP Heatshield (1)
- 3.5" V-Band Clamp (1)
- 3" Crush Gasket (1)
- Turbocharger Stud (5)
- Turbocharger Crimp Nut (5)
- M10x1.5 Nut (2)
- M10 Exhaust Hardware Assembled (2)
- M6x1.0x8mm Bolt (3)
- M6 Washer (3)

Step 1 — Getting Started



- First and foremost; **THANK YOU** for becoming a part of the CorkSport Family. We hope to bring you the highest level of Parts, Customer Service, & Support

ⓘ How To Use These Instructions: The instruction format will relate colored marking in the image to the color dot in the text to the right of the image

⚠ The vehicle featured in this installation guide is a 2021 Mazda3 Turbo equipped with the CorkSport 80mm Catback exhaust system. Downpipe installation on CX30/CX50 and OEM or smaller CorkSport exhaust systems will be similar. Fitment with other exhaust manufacturers is not guaranteed

Step 2 — Lifting the Car & Locating the Downpipe

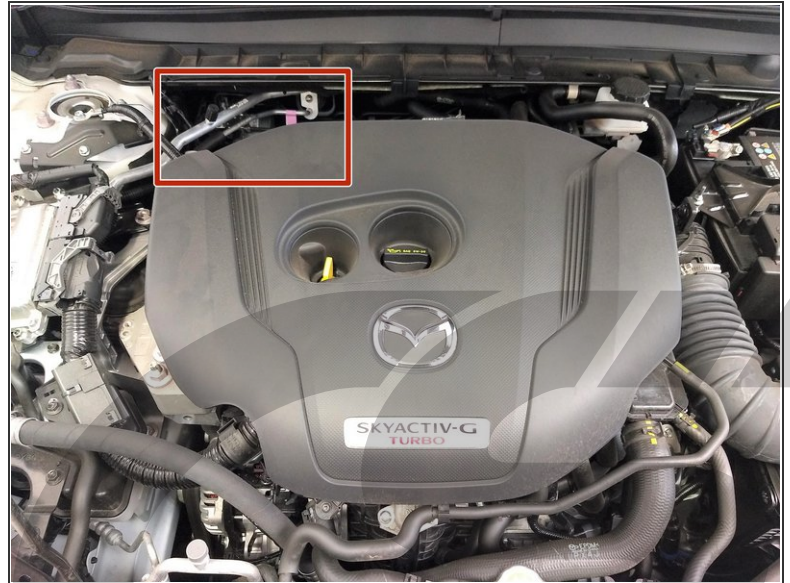

⚠️ Ensure the vehicle is parked on a level surface before proceeding

- Start by lifting up the front of the car using the hydraulic jack and jack stands

⚠️ Be sure to reference your owners manual for jack points and the jack manufacturer's instructions for proper practices

- The downpipe is located in the back of the engine bay on the driver's right-side of the vehicle

Step 3 — Remove the Engine Cover and Disconnect the Battery

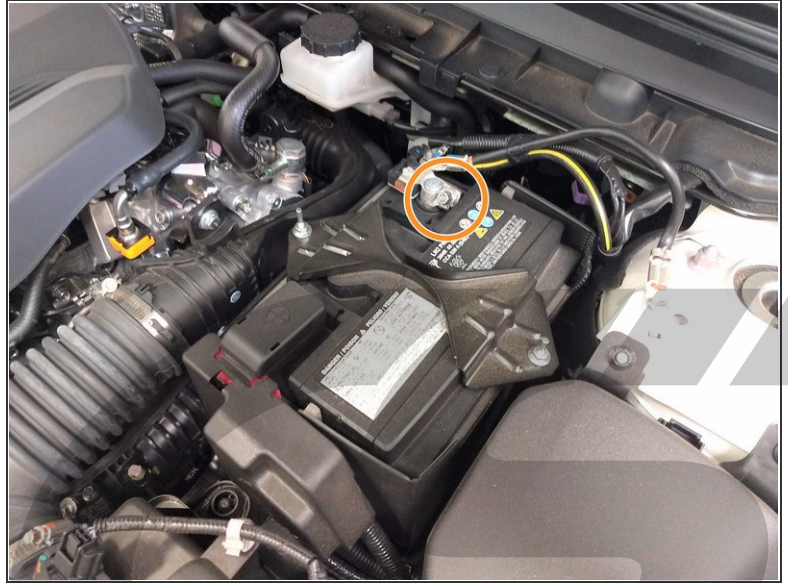
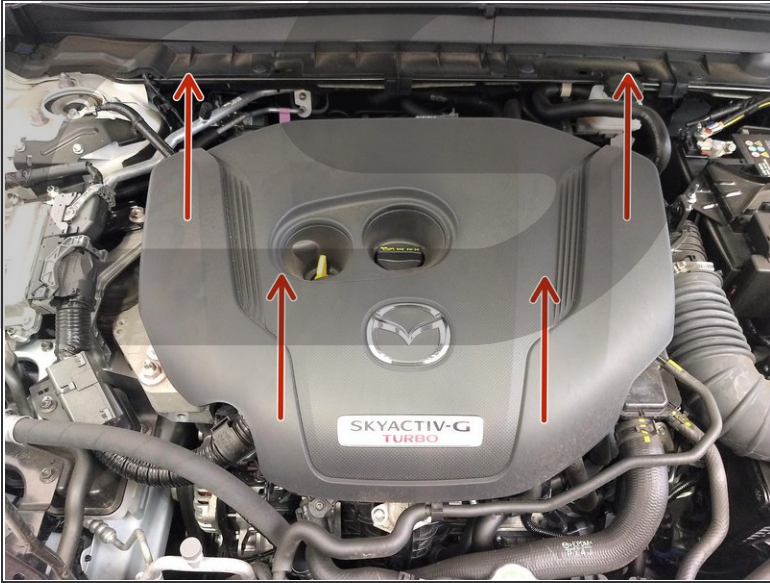

- Lift upwards on the plastic engine cover to pop it free from the four rubber mounting locations
- With a **10mm socket and ratchet**, disconnect the negative terminal of the battery and tuck out of the way

Step 4 — Remove the Windshield Cowling - Part 1

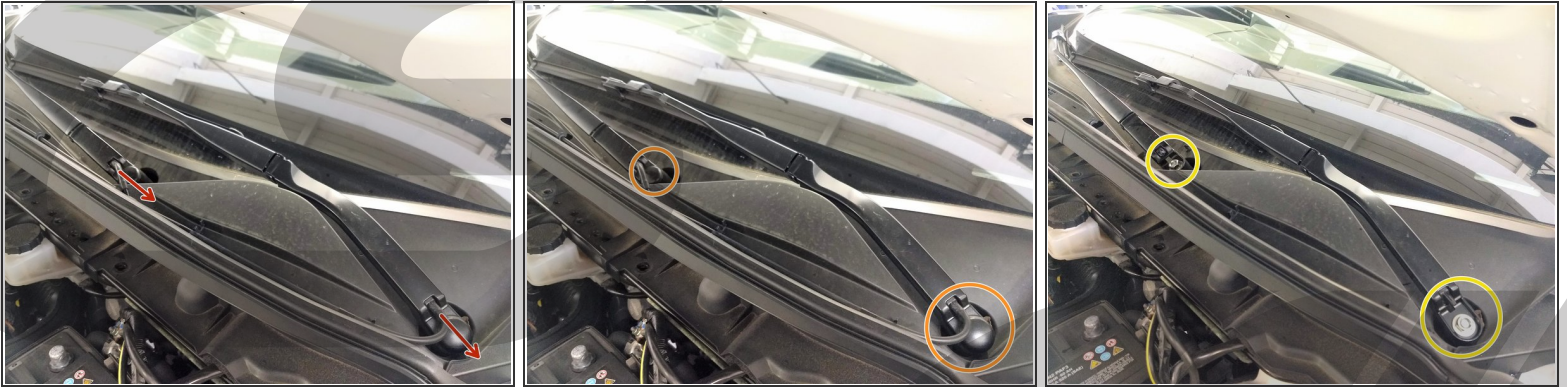

- Disconnect the **Two(2) Windshield Washer Lines** from the windshield wipers by pulling away as shown
 - ⓘ Be careful not to rip the hoses. Twisting the hose slightly helps break it free from its fitting
- Remove the **Windshield Wiper bolt-covers** by simply squeezing the edges and pulling upward
- Using a **14mm Socket and Ratchet**, remove the **Two(2) nuts** securing the Windshield Wipers
- Remove the windshield wipers from the vehicle by simply pulling away from their mounting points
 - ⓘ Rocking the wiper back-and-forth may help break it free from the splines

Step 5 — Remove the Windshield Cowling - Part 2

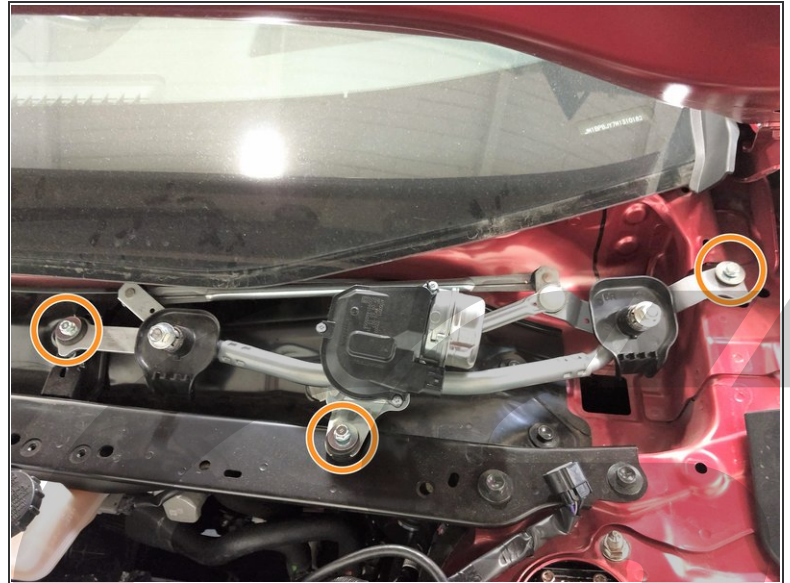
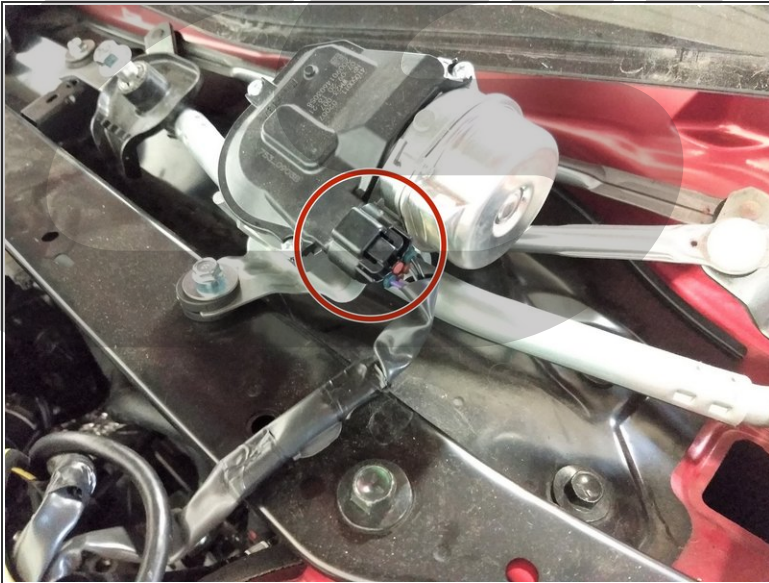

- Separate the hose on the passenger-side of the vehicle by pulling apart at the fitting shown
 - Located on both ends of the cowl, there is a blue plastic retainer that secures the rubber trim to the vehicle. Stretch the rubber trim piece over the blue retaining pin to release it
 - Remove the **Five(5) plastic push pins** with a **flathead screwdriver**
 - Gently pull the plastic cowl away from the windshield, then remove it from the vehicle
- ⓘ The Plastic Cowling is a two-piece design that can separate in the middle. Try to keep both pieces together when removing from the vehicle

Step 6 — Remove the Windshield Cowling - Part 3

- Remove the Windshield Wiper Motor Electrical Connector
 - With a **10mm Socket and Ratchet**, remove the **Three(3) 10mm bolts** securing the windshield wiper motor and mechanism
 - Carefully remove the windshield wiper motor/mechanism from the vehicle
- ⚠ Be careful to avoid contact with the windshield. Failure to do so may result in damage to the windshield**

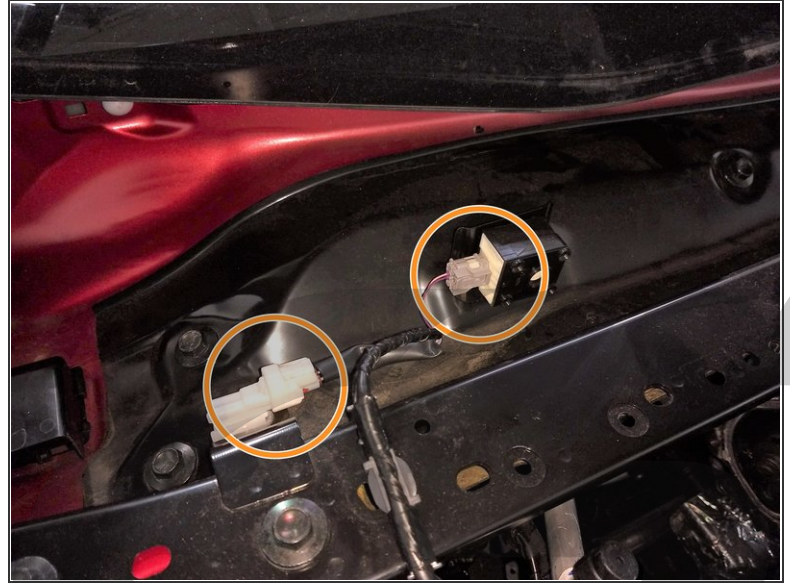
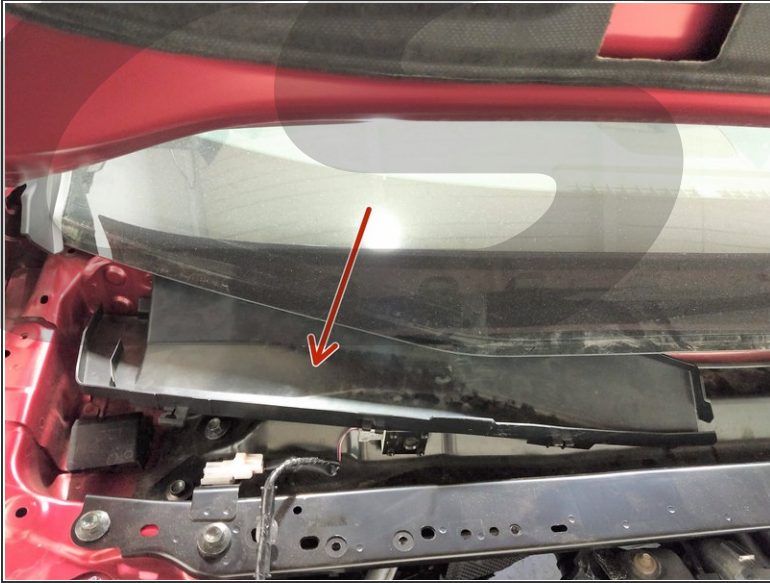
Step 7 — Remove the Windshield Cowling - Part 4 (Mazda3/CX30)

i Mazda CX50: Skip to next step

- Remove the protruding plastic trim piece from the passenger-side of the vehicle. This is done by firmly wiggling the trim piece while pulling outward
- i** RHD vehicles may have this trim piece located on the opposite side from pictured
- Disconnect the **Two(2) electrical connectors** shown

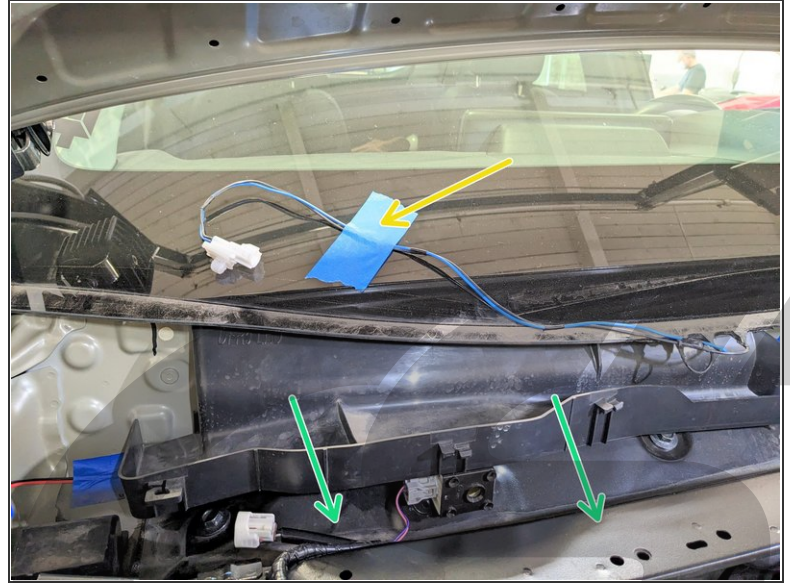
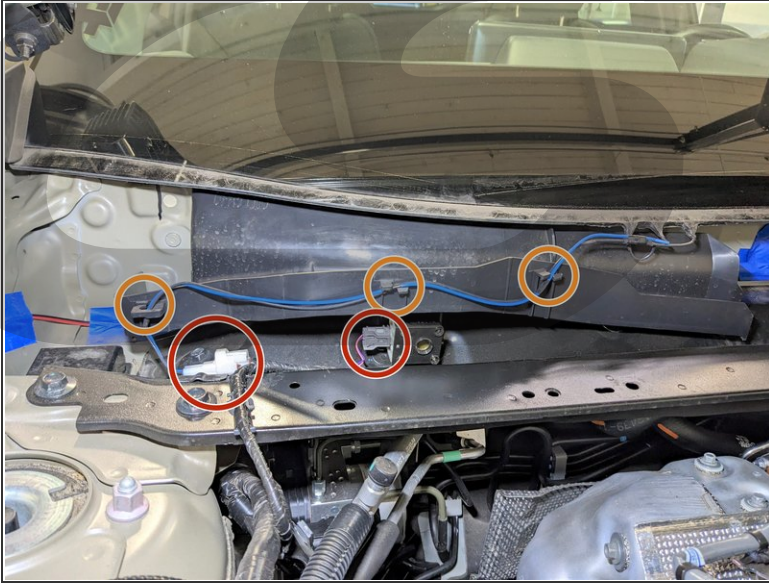
Step 8 — Remove the Windshield Cowling - Part 4 (Mazda CX50)

- Unplug the electrical connectors shown
- Remove the blue wire from its clips in the locations shown
- Secure the wire to the windshield with a strip of painter's tape, as shown
- Remove the Black Plastic Trim by gently, but firmly pulling away from the vehicle

Step 9 — Remove the Windshield Cowling - Part 5

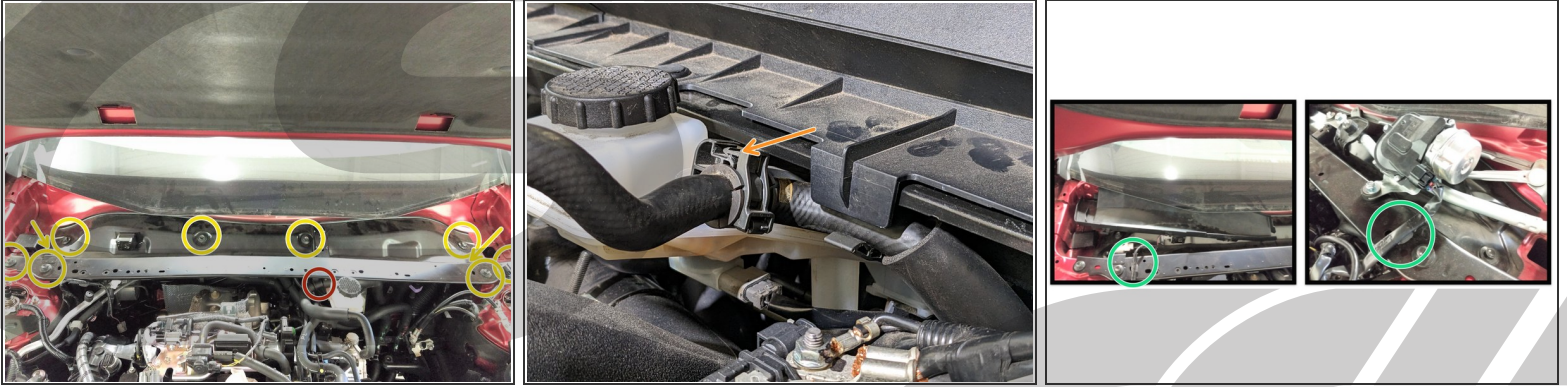

- Mazda3/CX30: With a flathead screwdriver, remove the rubber hose from the plastic clip in the location shown
- Mazda CX50: With the end of a flathead screwdriver, undo the clasp securing the rubber hose to the Metal Cowling piece, then remove the hose from the clasp
- With a **14mm Socket and Ratchet**, remove the **Ten(10) bolts** securing the metal cowling to the vehicle
- Lift the metal cowl slightly, exposing the underside of the Two(2) electrical harness clips
- Using a pair of needle-nose pliers, disconnect the Two(2) electrical harness clips from the metal cowling
- Carefully remove the Metal Cowl Piece from the vehicle

Step 10 — Remove the O2 Sensor and OEM Downpipe Heatshield

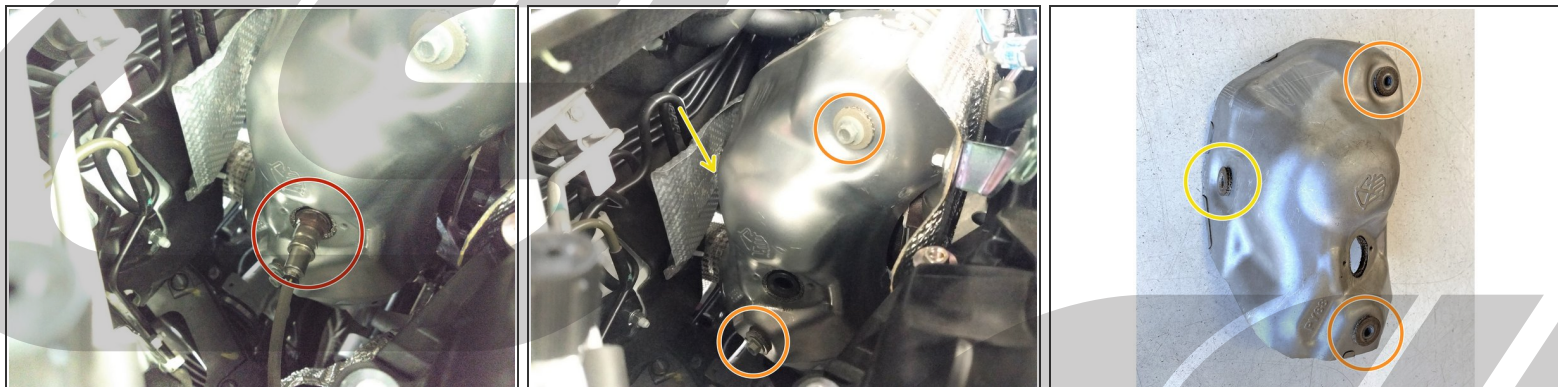

- With an O2 Sensor removal socket or 22mm wrench, remove the O2 sensor from the OEM Downpipe
 - Place the O2 Sensor safely out of the way, being careful not to damage it
- Using a **10mm socket or wrench**, remove the two visible bolts holding the heatshield to the downpipe
- Using a **10mm wrench**, remove the final bolt from the backside of the downpipe
- Remove the downpipe heatshield from the vehicle

Step 11 — Mazda3, CX30: Remove Underbody Pieces - Part 1

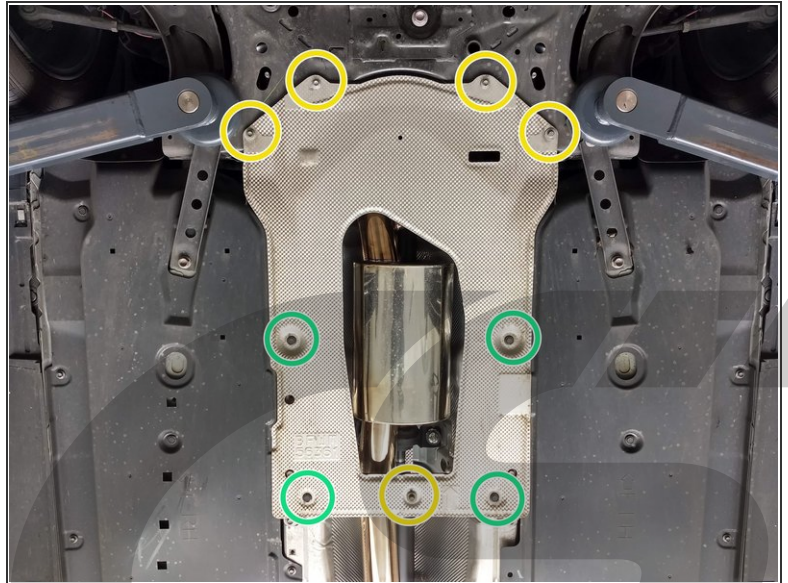
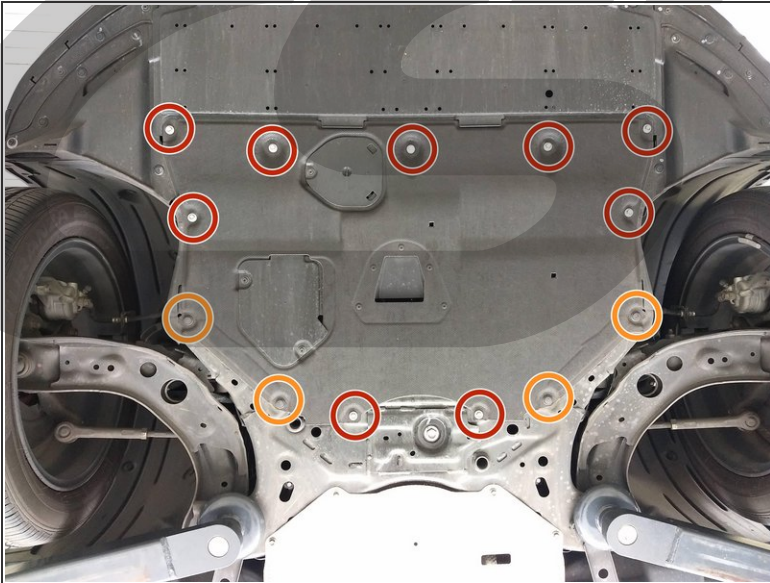

- i Mazda CX50: Skip to Step 13
- i Head underneath the car as we will be removing underbody shielding to access the rest of the downpipe
- Underneath the car, remove the **Nine(9) 10mm bolts** from the rear section of the engine underbody tray using a **10mm socket and ratchet**.
- With a **flathead screwdriver**, remove the **Four(4) small push clips** in the locations shown
- Remove the rear section of engine underbody tray from the vehicle and set aside
- Remove the **Five(5) 10mm bolts** from the Silver Exhaust Heat Shield
- Remove the **Four(4) Plastic Push Pins**
- Remove the Silver Exhaust Heat Shield from the vehicle and set aside

Step 12 — Mazda3, CX30: Remove Underbody Pieces - Part 2

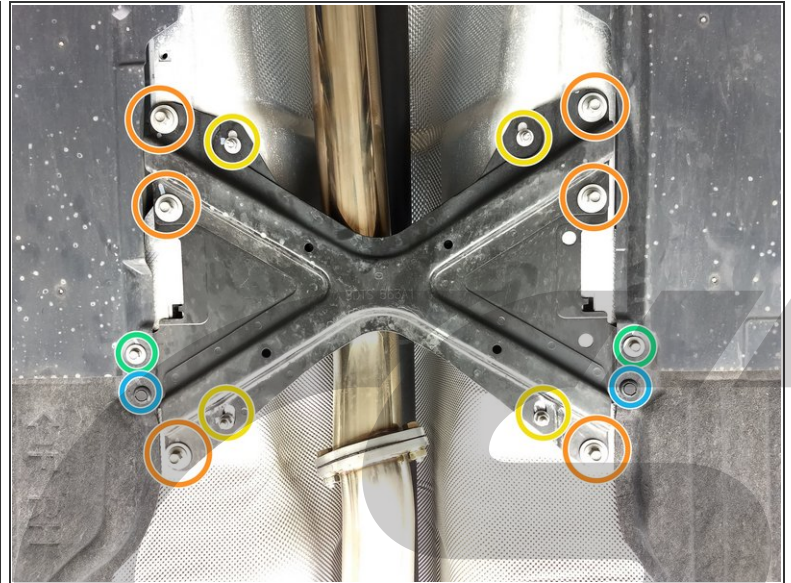
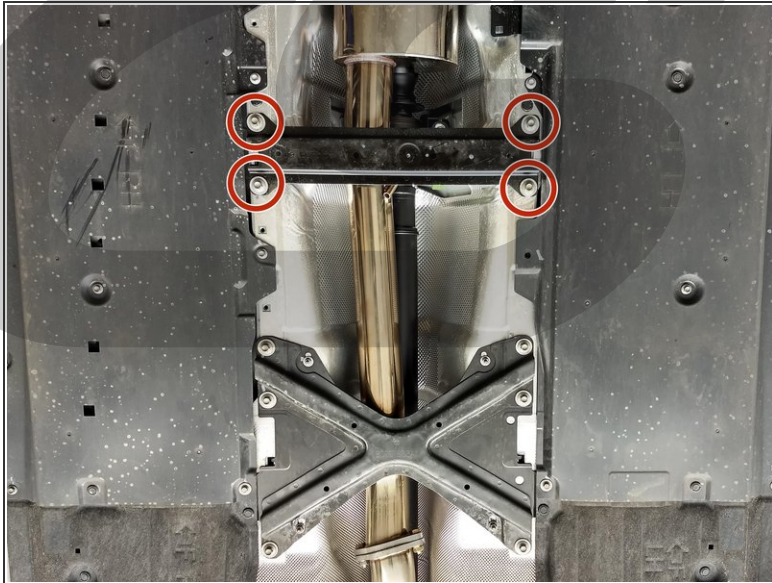

- Remove the **Four(4) 12mm Bolts** securing the front crossmember to the vehicle
 - Push the crossmember rear-ward. The brace will then drop on the right-hand side, then it can be removed from the vehicle
- Remove the **Six(6) 12mm bolts** from the rear X-brace
- Remove the **Four(4) 10mm nuts** with a **10mm deep socket**
- Remove the **Two(2) 10mm bolts**
- Remove the **Two(2) plastic push pins**
- Push the rear X-brace rear-ward. The brace will then drop on the right-hand side. Peel back the plastic and carpeted trim to allow clearance for the brace, then remove from the vehicle
- Skip to step 16

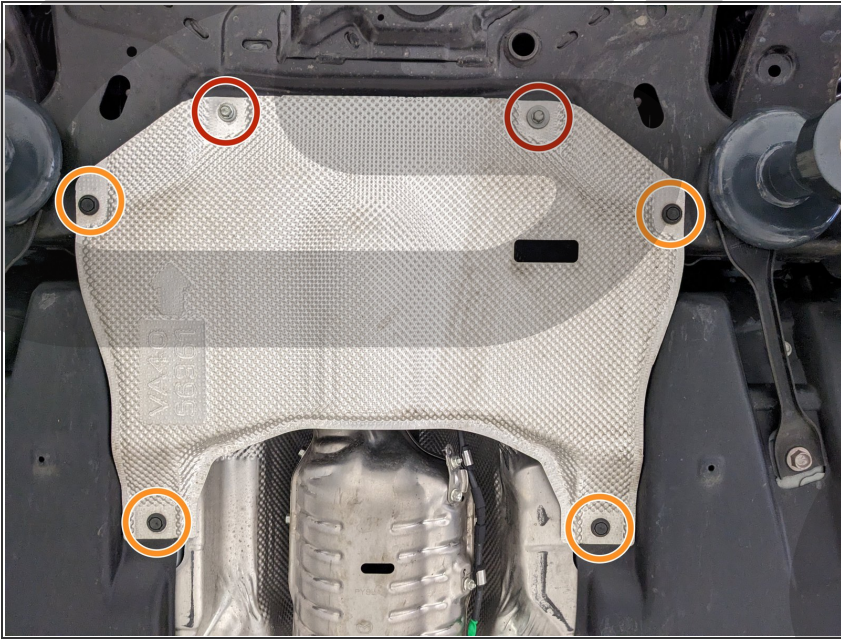
Step 13 — Mazda CX50: Remove Underbody Pieces - Part 1

- Remove the Two(2) 10mm Bolts
- Remove the Four(4) Plastic Fasteners with a flathead screwdriver
- Remove the Silver heat shield from the vehicle and set aside

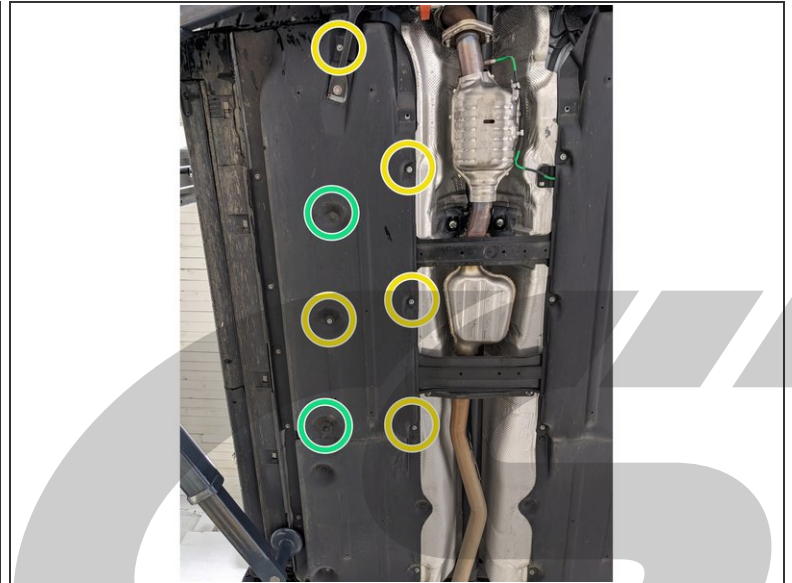
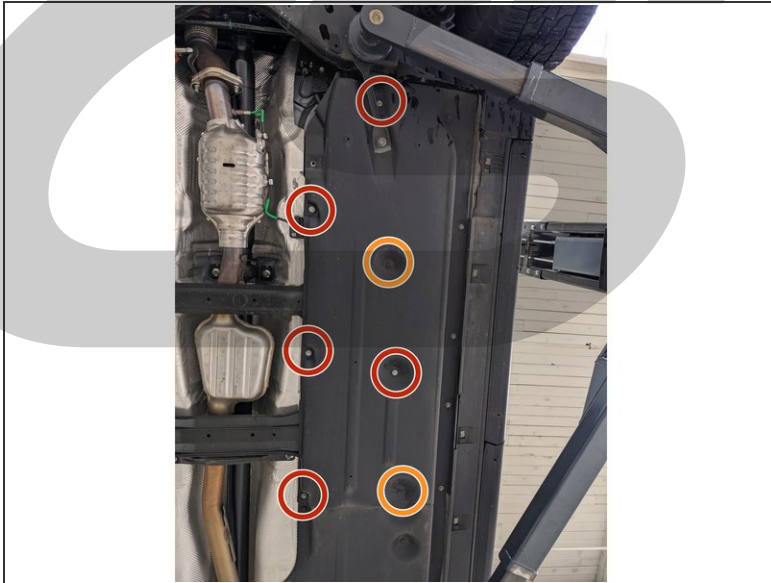
Step 14 — Mazda CX50: Remove Underbody Pieces - Part 2

- Partially remove the Left side Plastic undertray by removing:
 - Five(5) 10mm bolts
 - Two(2) plastic push pins with a flathead screwdriver
- Partially remove the Right side plastic undertray by removing:
 - Five(5) 10mm bolts
 - Two(2) plastic push pins with a flathead screwdriver
- ⓘ Allow the trays to hang to gain access to the Bracing shown in the next step

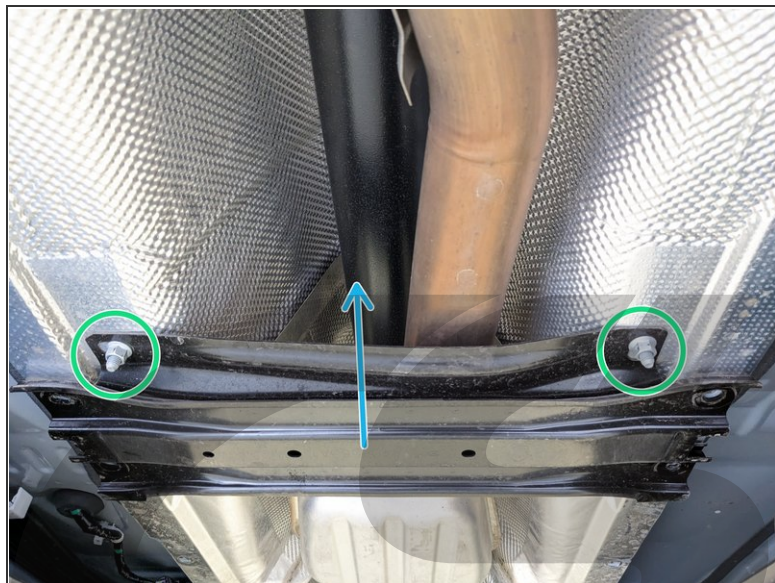
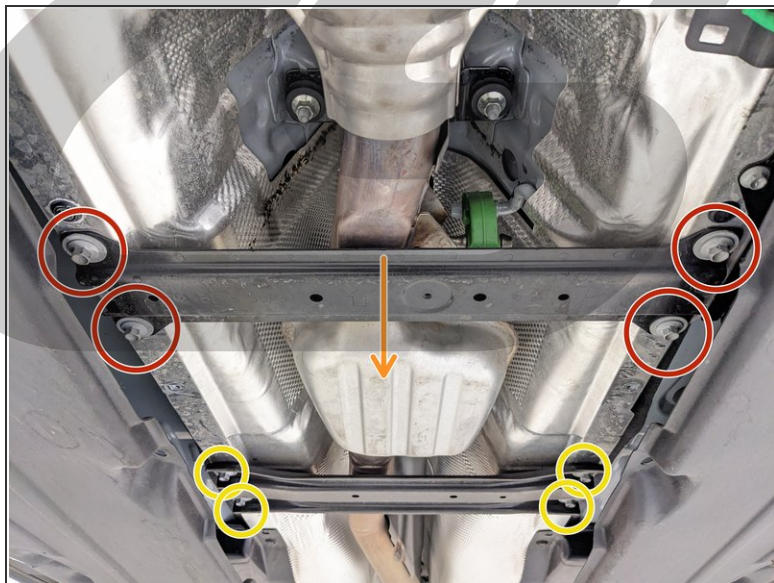
Step 15 — Mazda CX50: Remove Underbody Pieces - Part 3

- Remove the Four(4) 12mm bolts on the Front Underside Bracing
- Remove the Front Underside Bracing by pushing rearwards. The Brace should drop and be able to be removed from the car
- Remove the Four(4) 12mm bolts on the Rear Underside Bracing
- Remove the Two(2) 12mm Nuts on the Rear side of the Rear Underside Bracing
- Remove the Rear Underside Bracing by pushing rearwards. The Brace should drop and be able to be removed from the car

Step 16 — Remove Exhaust Midpipe - Part 1

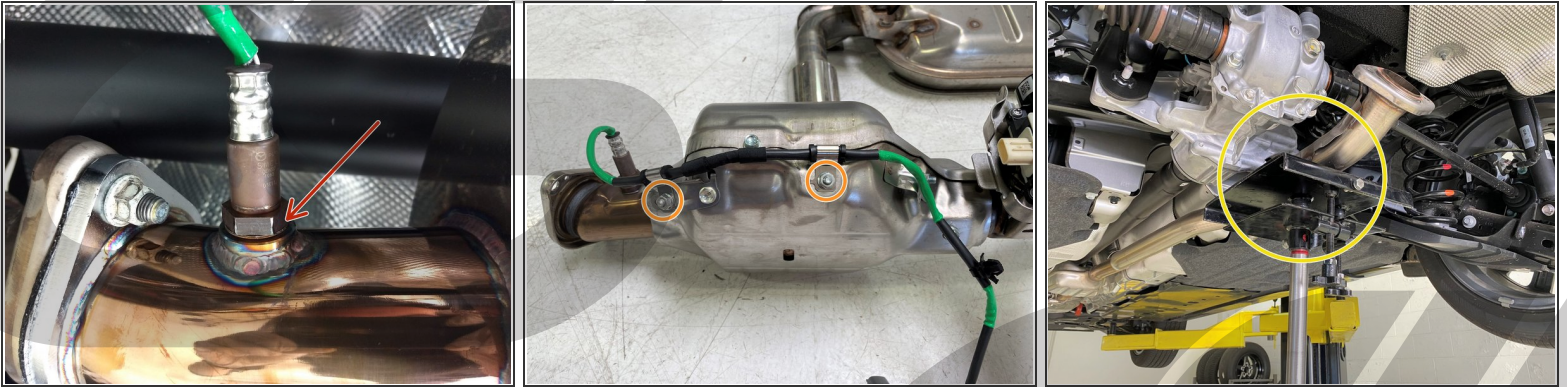

- i** The vehicle pictured in this installation guide is a Mazda3 equipped with the CorkSport 80mm Catback Exhaust. Smaller CorkSport exhaust systems will be identical. OEM exhaust removal will be similar
- Remove the **O2 Sensor** located at the front of the midpipe using a **22mm wrench** or **O2 sensor removal socket**
 - If you have an OEM midpipe, remove the **Two(2) 10mm nuts** securing the O2 Sensor wiring to the midpipe
 - Tuck the O2 sensor away in a safe location
 - **Place a jack stand under the rear section of the midpipe, or have a friend assist you when performing the following steps to avoid damage to your exhaust or any surrounding parts**

Step 17 — Remove Exhaust Midpipe - Part 2

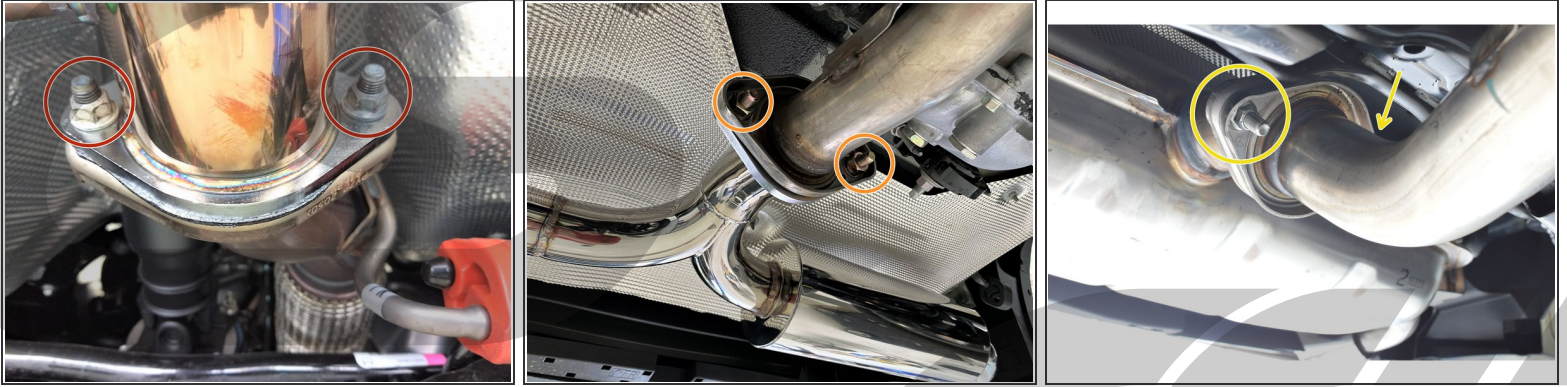

- Remove the **Two(2) 14mm nuts** securing the Turbo downpipe to the forward midpipe
- If your vehicle is equipped with a CorkSport Axleback exhaust system:
 - Remove the **Two(2) bolts** securing the rear-midpipe to the Axleback exhaust section with a **17mm wrench and 17mm socket-and-ratchet**
- If your vehicle is equipped with an OEM axleback system
 - Remove the **Two(2) 14mm nuts** securing the midpipe to the Axleback section

Step 18 — Remove Exhaust Midpipe- Part 3

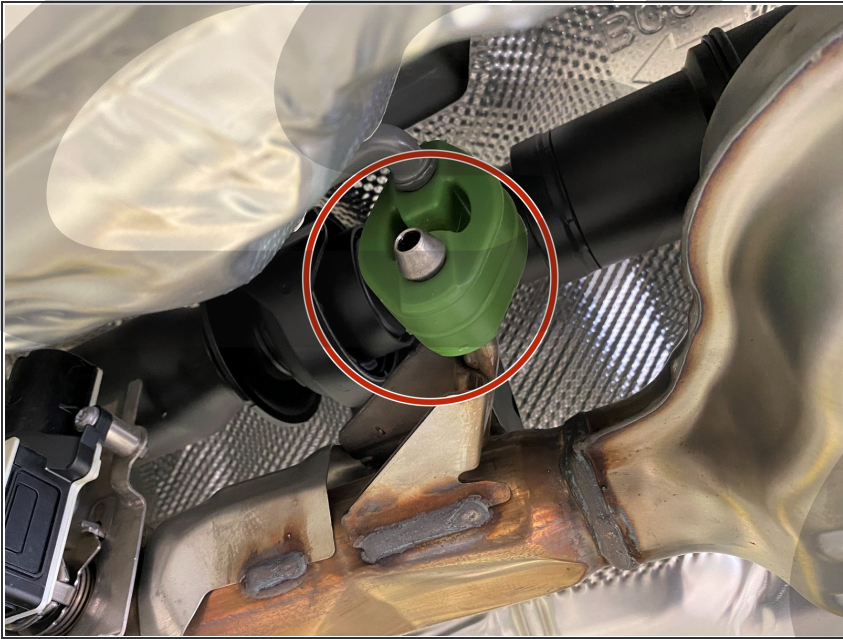

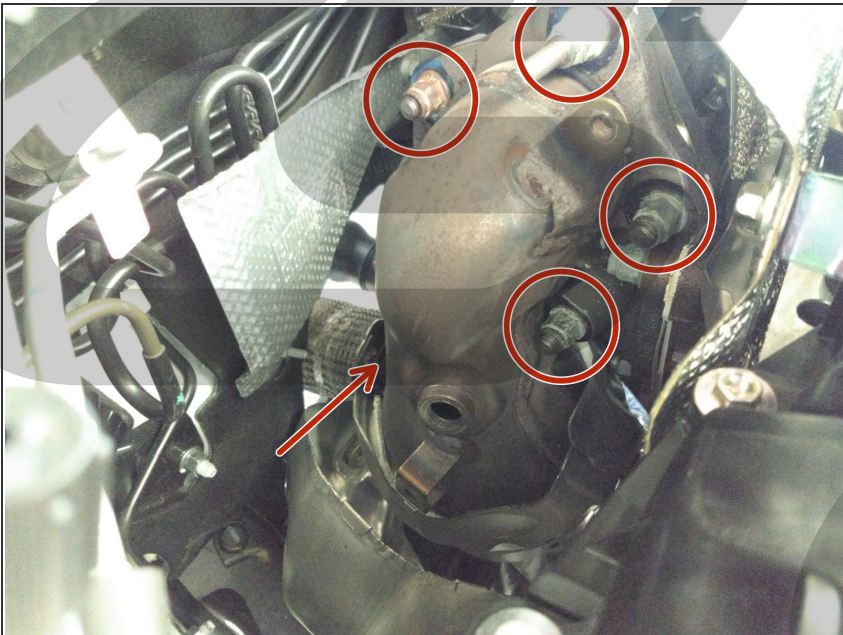

- Spray the rubber exhaust hanger located on the front of the midpipe with spray lubricant. (WD40, silicone spray, or even glass cleaner works well).
- Using **channel lock pliers** or **exhaust hanger pliers**, remove the midpipe hanger.
 - ⓘ Make sure to support the front of the midpipe by holding it up or by using another jack stand
- Remove the midpipe from the vehicle

Step 19 — Removing the OEM Downpipe Part 1





- ⚠ The OEM nuts that secure the downpipe to the turbocharger are "crimp" nuts. They will be difficult to remove and may pull the studs out with the nuts. We recommend spraying some penetrating fluid on the nuts and letting it sit for 30+ minutes to help with loosening

 If a nut is coming loose, and suddenly stops, **DO NOT FORCE THE NUT** and be careful not to break the stud. While all studs will be replaced in later steps, a broken stud **WILL** be very difficult to remove and **WILL** result in costly repair

 If a stud is broken in the process of downpipe removal, and cannot be retrieved via any remaining threads, the turbocharger must be removed to gain tool access. Please avoid this at all costs.

- Using a 14mm deep socket, remove the Five(5) Downpipe to Turbocharger nuts

 On the extra long studs, you may need to use a 14mm wrench instead

 It is okay if the stud comes out with the nut

Step 20 — Removing the OEM Downpipe Part 2

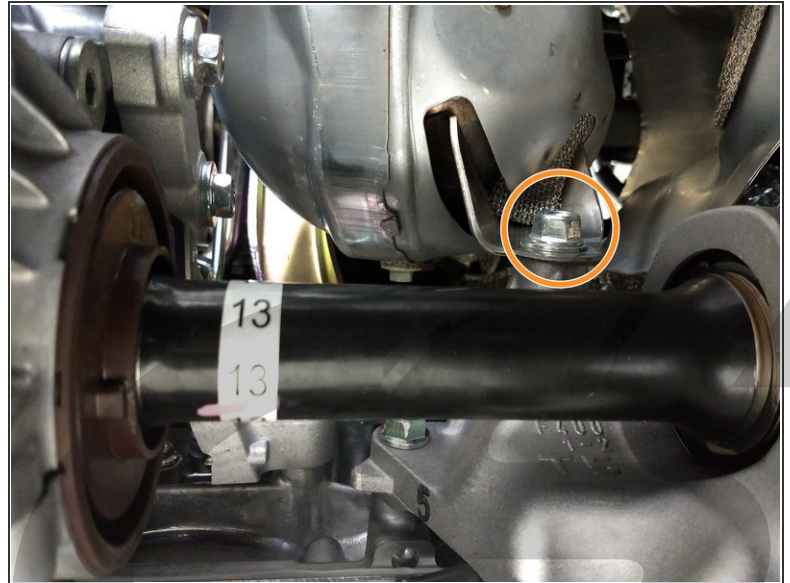
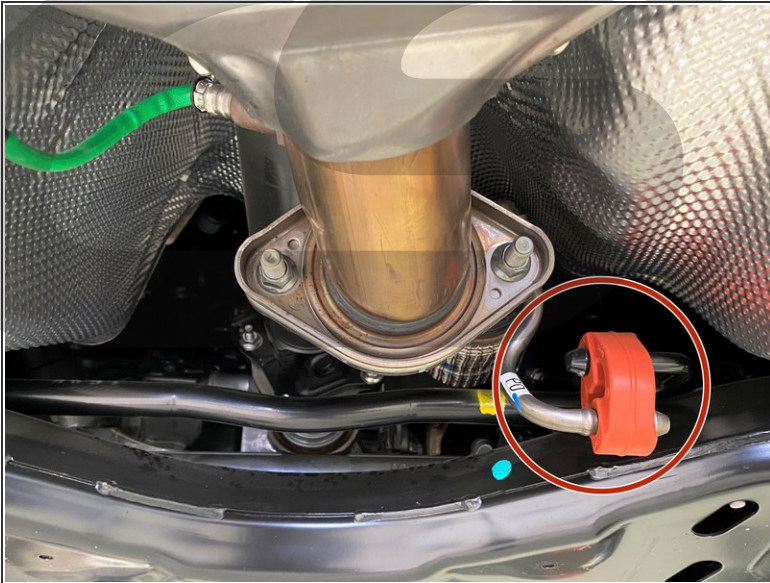

- Remove the **downpipe exhaust hanger** from the rubber hanger on the chassis using **exhaust hanger pliers** or **channel lock pliers**
- ⓘ Spraying some glass cleaner on the rubber hanger for lubrication will help with removal
- Follow the downpipe forward until you see where it attaches to the engine block with a support bracket
- ⚠ If all mounting studs have been removed from the turbo, the downpipe will be free to drop when the next step is performed. **Be sure to support the downpipe when performing the next step to prevent damage to the downpipe or surrounding components, or personal injury**
- Remove the **14mm bolt** holding the downpipe support bracket to the engine using a **14mm socket and ratchet**
- If there are studs remaining on the Turbo-side, carefully slide the downpipe off of the studs while it is supported by a friend underneath the car. Once the Downpipe is free, have a friend help you guide the Downpipe over the subframe and **remove from the top**
- If removing alone, carefully lift the downpipe with one hand, and use the other hand to maneuver the lower flange over the subframe and swaybar. The downpipe can then rest against the swaybar while you move to the top of the vehicle and remove the downpipe, being careful of surrounding components
- ⚠ **Exercise caution when maneuvering the downpipe out of the top of the vehicle to prevent damage to surrounding components**

Step 21 — Preparing for CorkSport Downpipe Part 1

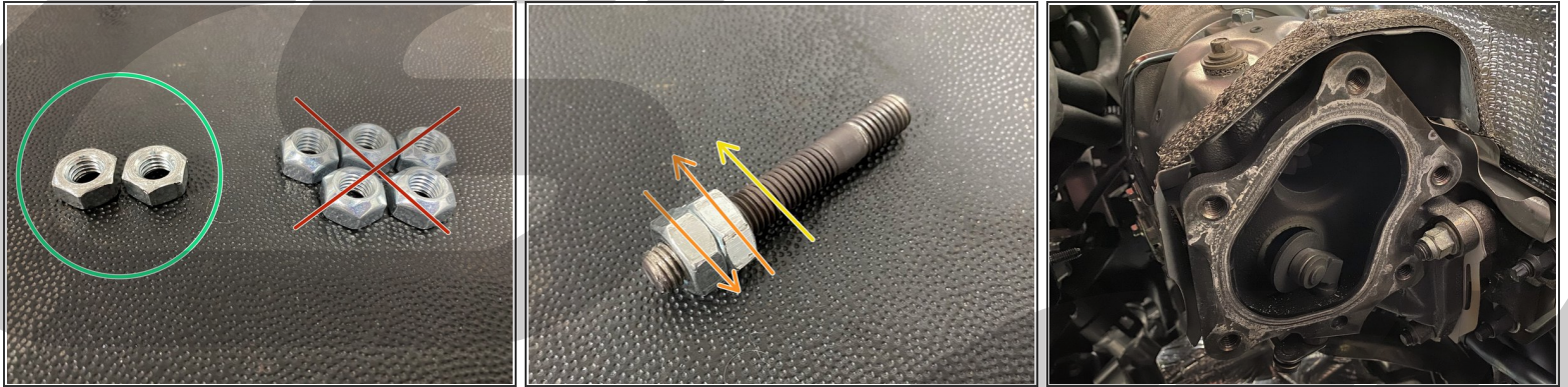

⚠ The following step is optional, however, we strongly recommend it as the OEM studs are easy to break due to their long length. **THE SAME WARNINGS FROM STEP 15 APPLY. PLEASE PROCEED WITH CAUTION**

- **If there are studs remaining on the Turbocharger**, locate the two M10x1.5 nuts in your hardware kit. These nuts are **not** "rounded" like the crimp nuts also supplied in your kit.
- ⓘ The following is shown on a bench for clarity. Procedure is the same on the car
 - Install both M10x1.5 nuts onto a stud as shown
 - Tighten the nuts against each other using two 17mm wrenches. "Tighten" the upper nut and "loosen" the lower nut to snug them against each other
 - Turn the the lower nut counter-clockwise. If done correctly, this will begin to remove the stud from the turbo
 - Repeat this process for the four other studs in the turbocharger. Once complete, it will look like image 3
- ⚠** Once complete, do not discard the OEM studs. These are needed if you ever decide to go back to the OEM downpipe

Step 22 — Preparing for CorkSport Downpipe Part 2

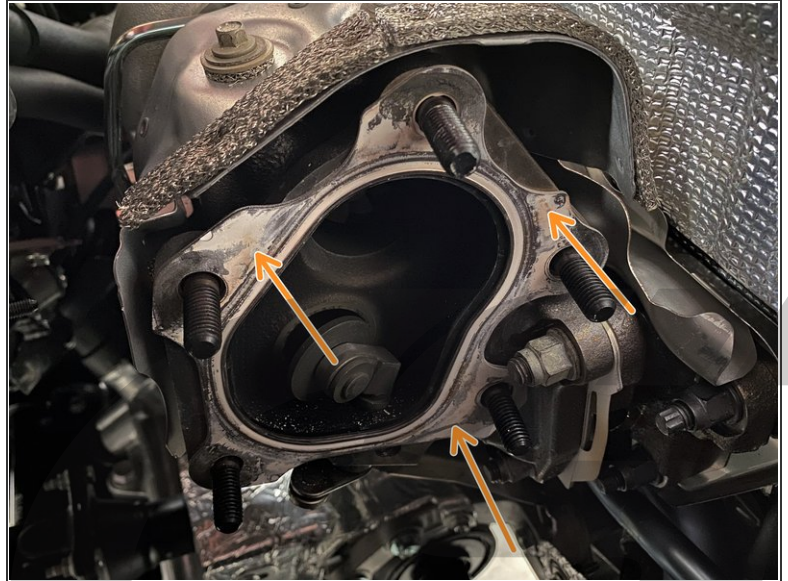
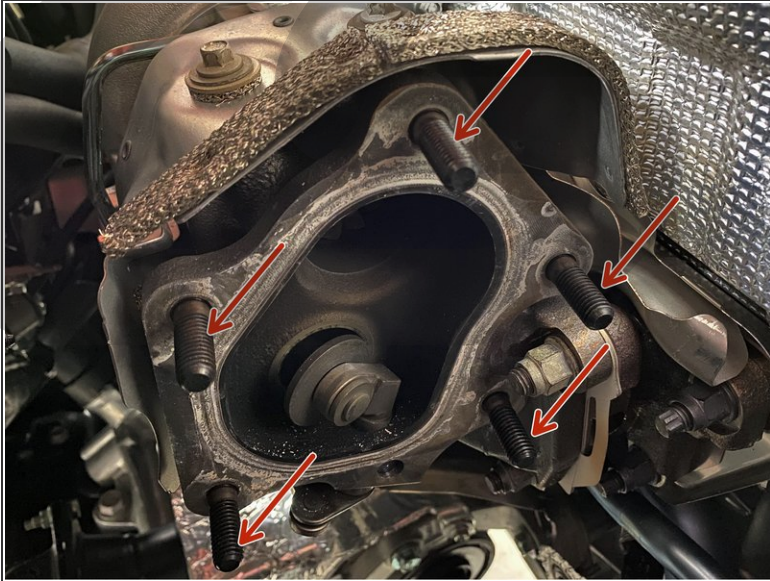

- Install the supplied CorkSport studs with the shorter end threaded into the turbocharger. Hand tight is all that is required
- ⓘ A small amount of anti-seize is recommended for the studs
- Install the OEM gasket over the studs. If a new one is needed, it is Mazda part number **PY88-13-490**

Step 23 — Mazda CX50: Assemble the Downpipe

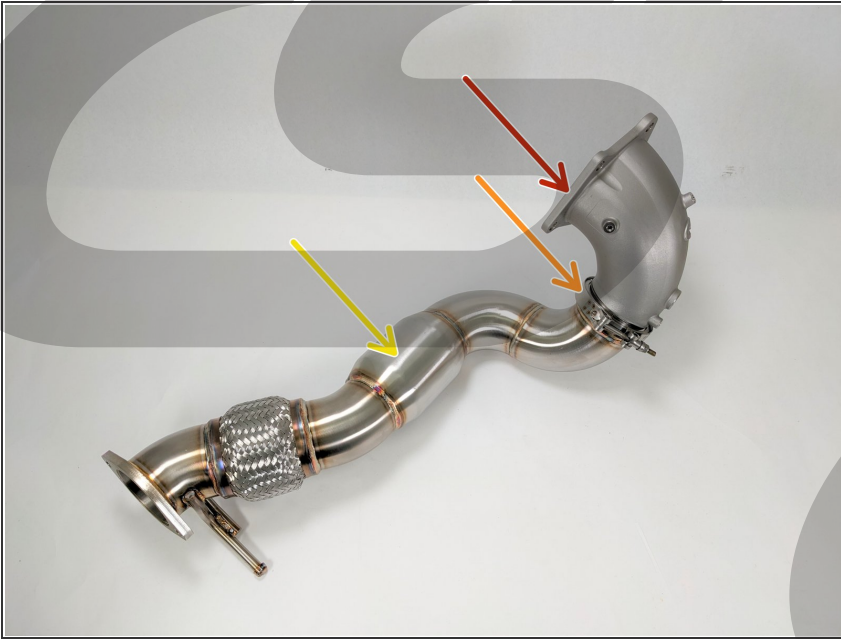

- ① Mazda 3/CX30: Skip to step 25
- On a workbench, assemble the downpipe as shown
 - Cast Bellmouth
 - V-band clamp
 - Downpipe Section
- Ensure there is an even gap between the Upper Bellmouth and the Lower Pipe section
- With a **10mm Deep Socket and Ratchet**, tighten the V-band clamp so that the Upper Bellmouth can swivel, but does not separate from the Lower Pipe Section

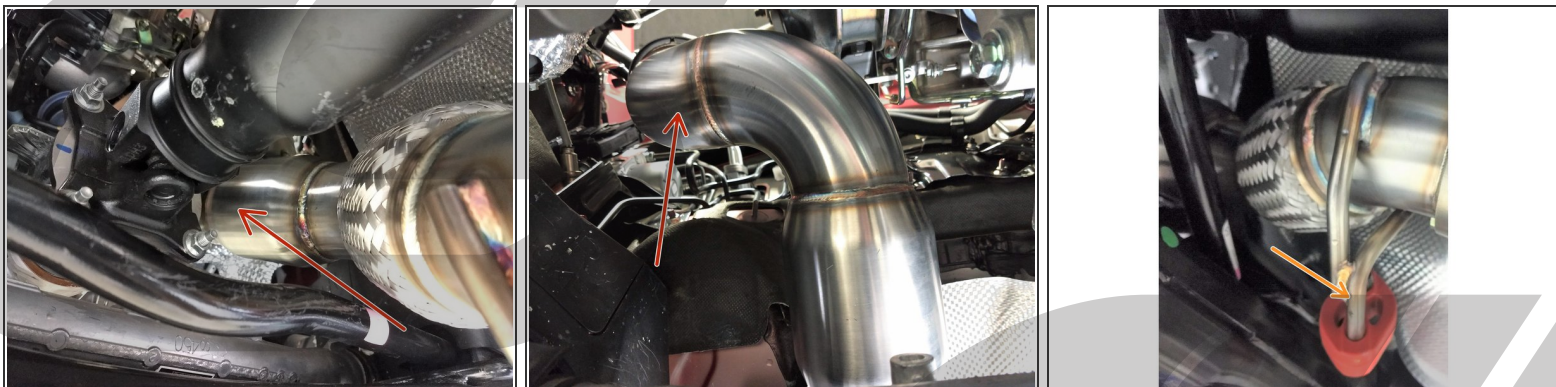
Step 24 — Mazda CX50: Install the CS Downpipe

- Underneath the vehicle, maneuver the Downpipe assembly into place
 - ⓘ Swivel the Upper Bellmouth Section and rotate the assembly as needed
 - ⓘ Move carefully to avoid scratching the downpipe or damaging surrounding parts
- Place the exhaust hanger on the CS downpipe through the rubber hanger on the chassis. This will help keep the downpipe in position
- Allow the upper section to rest against the frame rail while the next step is completed

Step 25 — Installing the CorkSport Downpipe Part 1

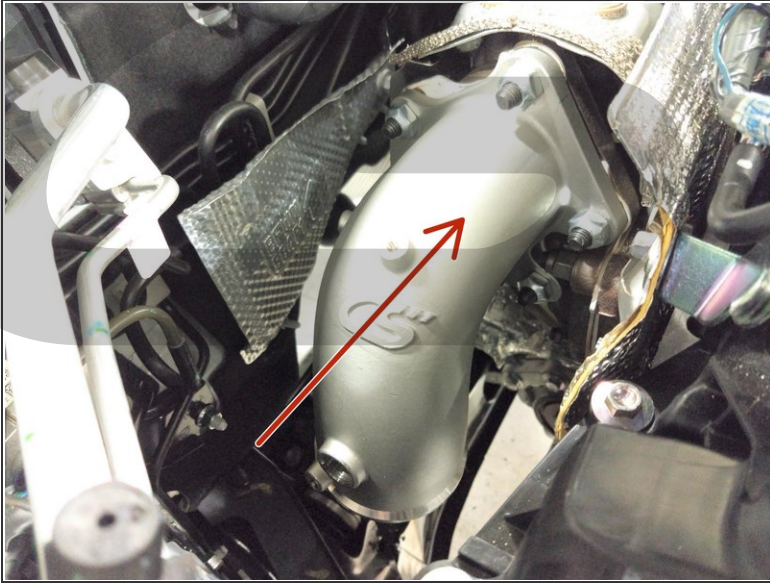

- Install the CorkSport downpipe bellmouth onto the studs of the turbocharger
- Using the supplied crimp nuts and a 17mm socket and ratchet, secure the CS bellmouth to the turbocharger. Only tighten until snug for now
- Tighten all crimp nuts to **34-45ft-lbs** in the pattern shown below:
 - Nut #1
 - Nut #2
 - Nut #3
 - Nut #4
 - Nut #5

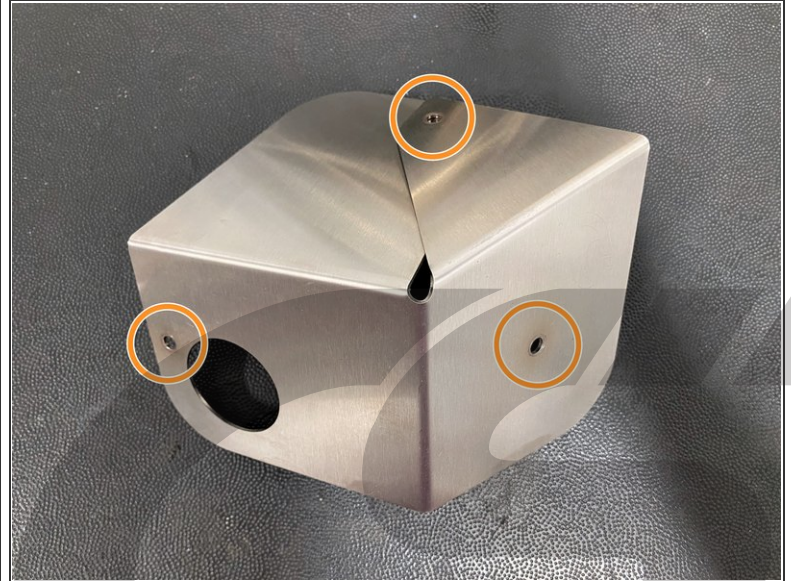
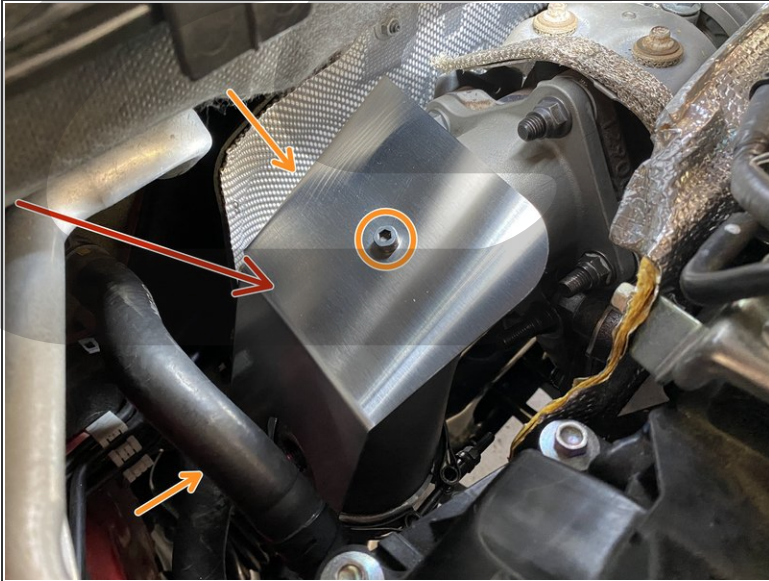
Step 26 — Installing the CorkSport Downpipe Part 2

- Place the CorkSport bellmouth heatshield into position
- Secure the CS bellmouth heatshield using the three supplied M6 bolts & washers. Tighten until snug using a 10mm wrench
- ⓘ The car used for images has different hardware than what will come in your kit. Look for the very short hex head bolts and small washers in your kit!
- ⓘ Heat shield shown off the car in Image 2 for hole location reference

Step 27 — Installing the CorkSport Downpipe Part 3

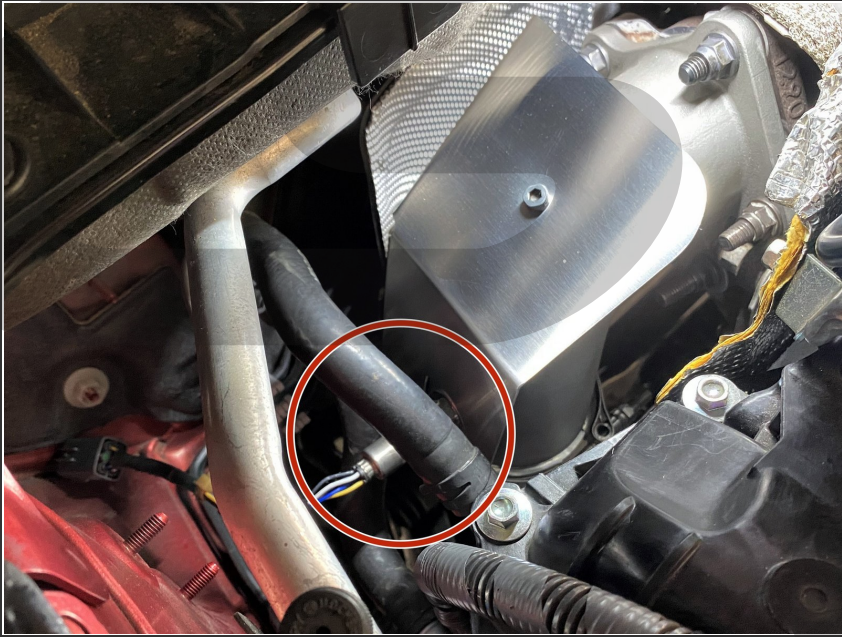

- Install the O2 sensor into the CS bellmouth and tighten hand tight
- Using an O2 sensor socket and ratchet, OR 22mm wrench, fully tighten the O2 sensor. **Do not over tighten, 22-39ft-lbs** is the OEM spec, or about 1/4 to 1/2 turn past hand tight

Step 28 — Installing the CorkSport Downpipe Part 4

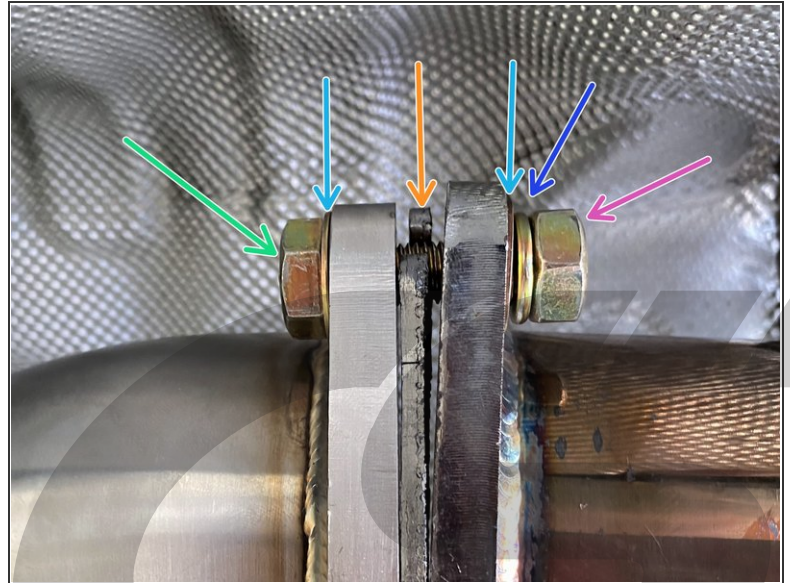
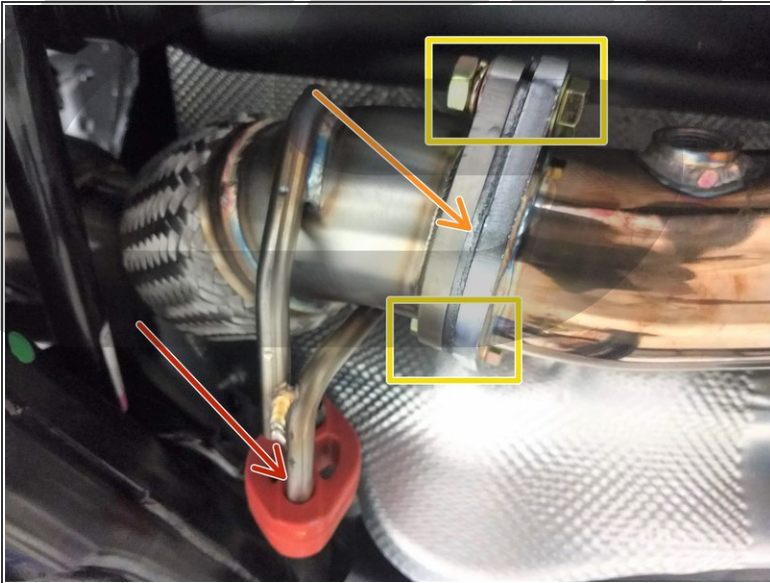

- Moving back under the car, lift the CorkSport downpipe into position, then reinstall the midpipe in reverse order of removal. **Leave all hardware loose for now**
- Place the exhaust hanger on the CS downpipe through the rubber hanger on the chassis. This will help keep the downpipe in position
- Reinstall the midpipe and place the supplied "Remflex" crush gasket in between the CS downpipe and the midpipe section of exhaust
- Secure the downpipe to the midpipe using the supplied M10 hardware. **Leave hardware loose for now**. Match hardware stack as shown:
 - M10x1.25x35mm bolt
 - M10 flat washer
 - M10 lock washer
 - M10x1.25 nut

Step 29 — Installing the CorkSport Downpipe Part 5

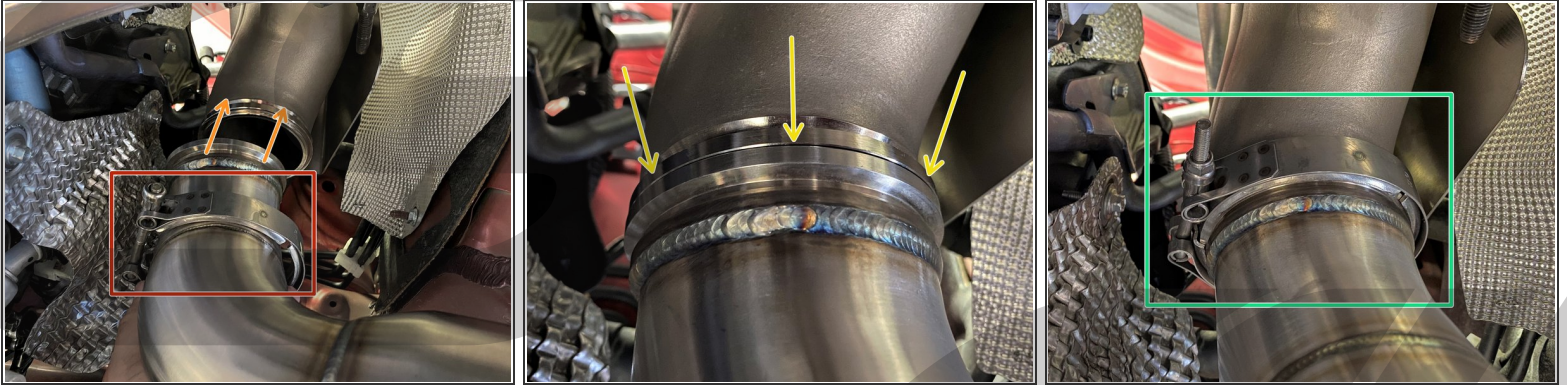

- i Mazda CX50: Tighten the V-band clamp to 8-12ft-lbs using a 10mm socket and ratchet, then skip to the next step
 - Place the supplied V-band clamp over the end of the downpipe. Match the orientation shown for easy access when tightening
 - i You may need to remove the nut from the clamp to fit the clamp over the V-band flange
 - Lift the downpipe into position against the cast bellmouth
 - Ensure the downpipe is sitting even and flat against the cast bellmouth all around. A very small gap between the flanges is expected as the inner ring does the sealing
 - Once happy with fitment, use the V-band clamp to hold the two flanges together. Tighten to **8-12ft-lbs.** using a 10mm socket and ratchet
 - i Overtightening can break the threaded portion of the v-band clamp
 - i Having a Second Person hold the downpipe in position while the other tightens will greatly help the installation process

Step 30 — Installing the CorkSport Downpipe Part 6

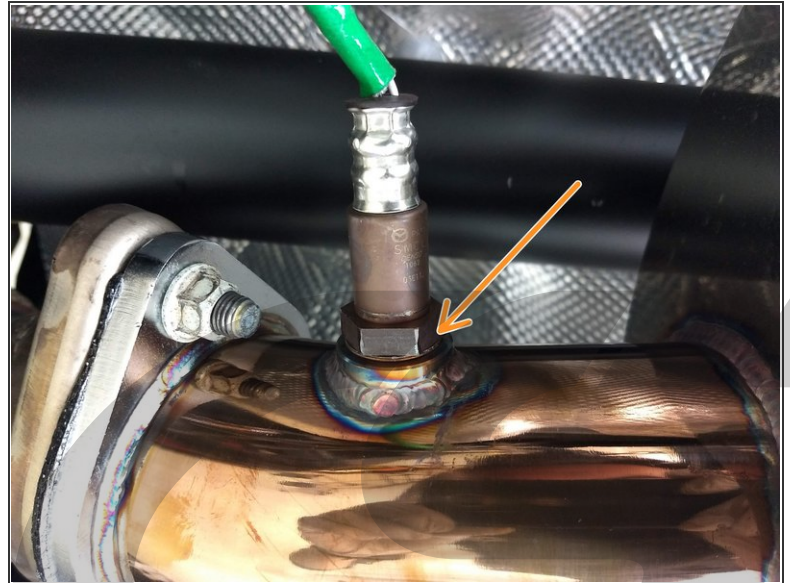
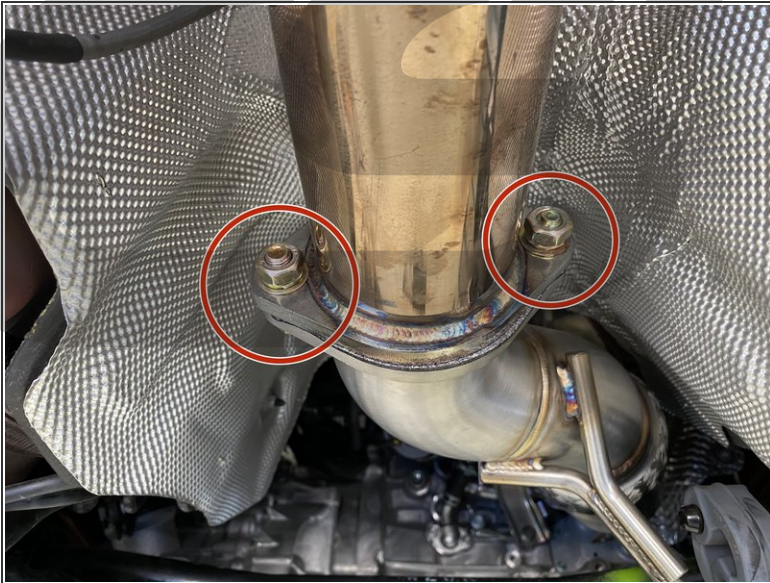

- Line up the downpipe flange, midpipe flange, and crush gasket so they are all centered with each other
- ⓘ If the flanges do not seem to line up, you may need to loosen the v-band clamp at the bellmouth and rotate the downpipe slightly
- Tighten the two bolt flange hardware to **30ft-lbs.** using a **17mm socket, ratchet, and wrench.**
- Tighten the remaining midpipe hardware to **30ft-lbs** using a **17mm socket, ratchet, and wrench**
- Reinstall the O2 sensor into the midpipe to 22-39ft-lbs. **Do not overtighten**
 - If installing onto a CorkSport midpipe, remove the two metal tabs originally used to secure the O2 wiring to the midpipe
 - If installing onto an OEM midpipe, reinstall the **Two(2) 10mm bolts** securing the O2 sensor wiring to the OEM midpipe
- ⓘ Wipe down the exhaust with a cleaning agent and clean towel to remove any grease, dirt, or fingerprints. These can become baked into the exhaust with heat and become extremely difficult to remove

Step 31 — Reassemble the Vehicle - Mazda3/CX30

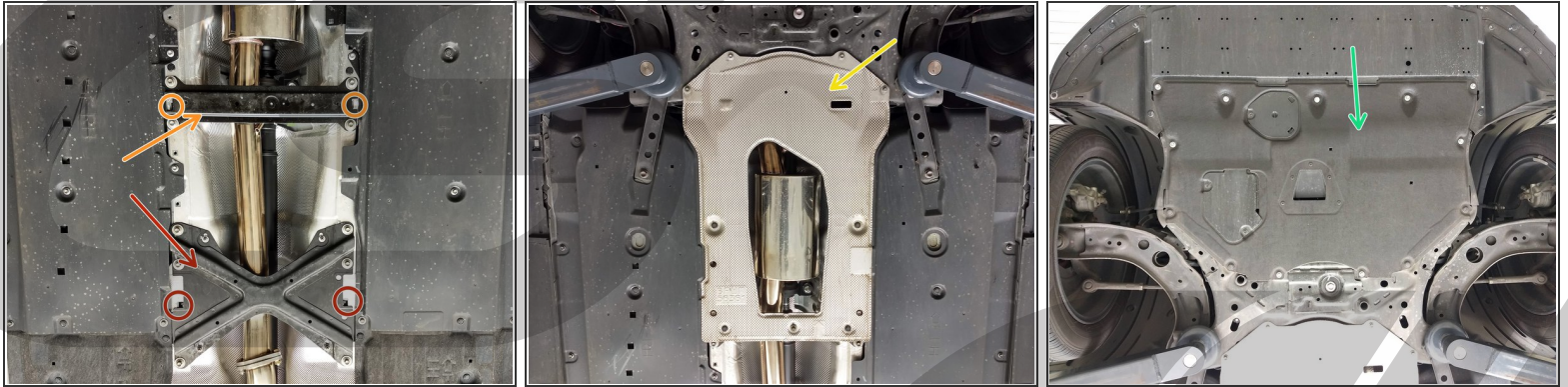

- Reinstall the Rear X-brace by sliding the left-side tab into its slot first, then the right-side, then pushing the brace forward into place
- ⓘ Note that the plastic and carpeted trim-piece lays **on the-outside-of** the rear portion of the X-brace where the 10mm bolt and plastic push pin are located
- Reinstall the Front Crossmember in the same manner as the X-brace
- Reinstall the Silver exhaust heat shield
- Reinstall the underbody engine cover
- Reinstall the Windshield Cowling in reverse order of disassembly
- Reconnect the Negative Battery Terminal

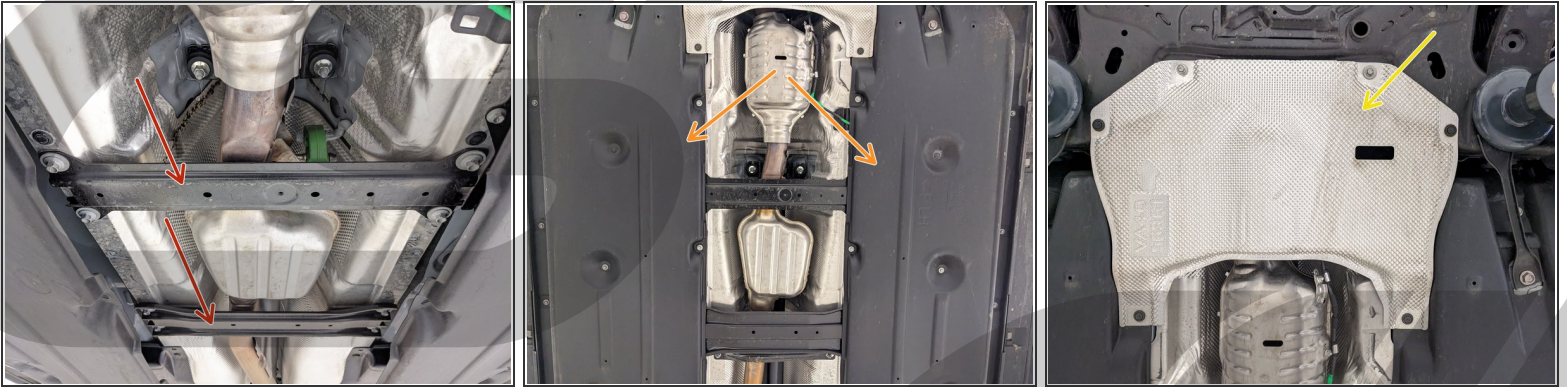
Step 32 — Reassemble the Vehicle - Mazda CX50

- Reinstall the Crossmember pieces
- Resecure the left and right-side plastic coverings
- Reinstall the Silver Forward Heat Shield
- Reinstall the Windshield Cowling in reverse order of disassembly
- Reconnect the Negative Battery Terminal

Step 33 — Installation Complete



- This completes your installation of the CorkSport Performance Turbo Downpipe!
- ⓘ Before the first start, wipe down the exhaust with a cleaning agent and clean towel to remove any grease, dirt, or fingerprints. These can become baked into the exhaust with heat and become extremely difficult to remove
- ⓘ Listen for any strange noises upon first start up. If any are present, you may have an exhaust leak and need to readjust the downpipe section and/or re-tighten the flanges.
- ⓘ A slight "burning off" smell will be present as the exhaust is heated for the first time. This should dissipate within a few minutes. If penetrating fluid was used to loosen the turbo studs, smoke will be visible upon first start, but should dissipate within a few minutes
- ⓘ An increase in Noise, Vibration, and Harshness (NVH) is normal upon installation of the downpipe, especially paired with larger exhaust systems. Listen for any ticking or rushing air around connection points and fix accordingly
- ⓘ We strongly recommend a tune to go with your downpipe as the exhaust will flow much better with the CorkSport Downpipe
- Contact us with any questions or concerns at sales@corksport.com or (360) 260-2675.
- Share your experience using #CorkSport on Instagram, Facebook, and Twitter.