

INSTALLATION INSTRUCTIONS



CORKSPORT "Modular Series" 3 Inch Downpipe

2006-2007 Mazdaspeed 6

PART #: ATE-6-110-XX

Need Help With Your Installation? Call (360)260-CORK



*We absolutely, positively,
deliver - every time.*

CORKSPORT.COM

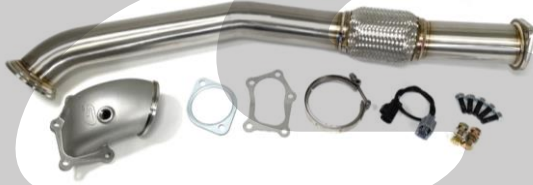

CORKSPORT "Modular Series" 3 Inch Downpipe

2006-2007 Mazdaspeed 6

PRODUCT DESCRIPTION:

Increase power and torque with the CorkSport V2 Downpipe for the 2006-2007 Mazdaspeed 6; available in Catted Downpipe or Catless Downpipe setups. New V2 design uses our modular system to improve flow, enhance fitment and make installation simpler in the cramped mazdaspeed6 engine bay. The design utilizes a cast stainless steel bell mouth with a v-band connection to 3" stainless steel piping.

Please let us know your feedback of the by submitting a review at: <https://corksport.com/>

PRE-INSTALLATION NOTES:

 Verify that your vehicle is completely cooled down prior to starting installation. If you are going to work on your car within an hour or two of driving it, use a fan to cool off the car.

 These instructions were written for reference only and the use of a factory service manual is recommended.

 High Pressure Fuel Pump (HPFP) Internals are required to safely operate the CS 3.0" Downpipe. A re-tune is also strongly recommended to safely operate the CorkSport 3.0" Downpipe. We recommend contacting a professional tuner.

 Make sure your vehicle is cooled down prior to starting installation. If you are going to work on your car within an hour of having driven it, use a fan to cool off the car.

 Fitment with EWG setups and EWG dump tubes will vary depending on your setup. CorkSport has specific dump tube setups to work with CSTX turbos and CS exhaust manifolds.

MATERIALS & TIME:

GENERAL INFO:



Time Est:
5hr



Difficulty:
4/5



CEL:
Yes



Warranty:
2-Year

TOOLING LIST:

- 8mm Socket
- 10mm Socket
- 12mm Socket
- 14mm Socket
- 15mm Socket
- 17mm Socket
- 3/8" Drive Ratchet
- 3" Extension
- 6" Extension
- 10mm Wrench
- 12mm Wrench
- 14mm Wrench
- 17mm Wrench
- 3/16" Allen Wrench or Socket
- Flathead Screwdriver
- Jack Stands
- Floor Jack
- O2 Sensor Socket
- Needle Nose Pliers



PARTS LIST:

- One (1) CorkSport "Modular Series" 3" Catted Downpipe OR
- One (1) CorkSport "Modular Series" 3" Catless Downpipe
- One (1) CorkSport Downpipe Bellmouth
- One(1) CorkSport Downpipe Turbocharger Gasket
- One(1) CorkSport 4" V-band Clamp
- Five (5) CorkSport Downpipe Mounting Studs
- Five (5) CorkSport Downpipe Lock Nuts
- Two (2) M10x1.25x70mm Bolts
- Two (2) M10x1.25 Nuts
- Two (2) M10, 31mm OD Washers
- One(1) CorkSport Lower O2 Harness Extension

ADDITIONAL PARTS THAT YOU MAY NEED:

- CorkSport GEN-6-575-17 Dump Tube (for CS turbos with EWG on turbine housing OR
- CorkSport AXL-6-442-31-V3 Upper Dump Tube (for CS manifold with EWG on manifold)

ORDER OF OPERATIONS & TABLE OF CONTENTS:

	VEHICLE DISASSEMBLY	
	Section 1: Removing OEM Hood and Cowl	Pg. 4-7
	Section 2: Removing the OEM TMIC	Pg. 8
	Section 3: Removing the OEM Intake	Pg. 9-10
	Section 4: Removing the OEM Battery & Tray	Pg. 10-11
	Section 5: Removing the OEM Turbo Inlet Pipe	Pg. 12
	Section 6: Removing the OEM Heatshields	Pg. 13
	Section 7: Removing the OEM Exhaust Manifold	Pg. 14
	Section 8: Removing the OEM Downpipe Lower Sections	Pg. 15-16
	Section 9: Removing the OEM Downpipe Upper Section	Pg. 17-18
	CORKSPORT DOWNPIPE INSTALLATION	
	Section 10: Installing the CorkSport Downpipe	Pg. 18-23
	Section 11: EWG and Dump Tube Setup	Pg. 23-25
	VEHICLE REASSEMBLY	
	Section 12: Vehicle Reassembly and First Startup	Pg. 26

DETAILED INSTRUCTIONS:

1. Removing OEM Hood and Cowl



MS6 Hood & Cowl Removal is optional. However, we strongly recommend removing the hood & cowl as it allows for MUCH easier access during downpipe removal & installation.



Hood removal can easily damage the paint of your vehicle if you are not careful. We strongly recommend having a friend help during hood removal. The MS6 is also very heavy so be careful.



Verify that the car is on a level surface before proceeding. Use appropriate load rated hydraulic jack and jack stands to support the vehicle.

- a) Engage the parking brake and raise the front of the vehicle with a hydraulic floor jack, then support with jack stands. Please refer to the owners manual for proper jack and jack stand location.
- b) Lift up the hood and remove the two 12mm bolts located near the back corners of the hood. Support the hood upon bolt removal to ensure it does not bend the hinges. One bolt location circled in red in Figure 1a the opposite side of the hood is identical.
- c) Loosen the remaining two 12mm bolts holding the hood to the hinges. These do not need to be completely removed. One bolt location shown in blue in Figure 1a.
- d) Slide the hood free from the hinges and remove the hood from the vehicle. Store the hood in a secure place, safe from damage or chance of bending the corners.

- e) Remove the wiper arm bolt covers by prying them off using a flathead screwdriver. Shown circled in red in Figure 1b.
- f) Unbolt the wiper arms from the vehicle using a 12mm socket and ratchet. Bolt locations circled in red in Figure 1b.
- g) Remove the wiper arms from the vehicle. They can get stuck and require some effort to remove.

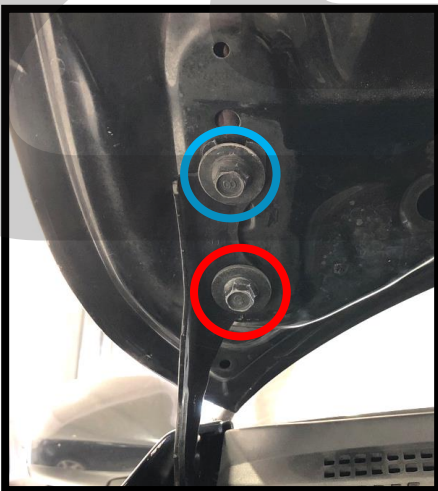

Figure 1a

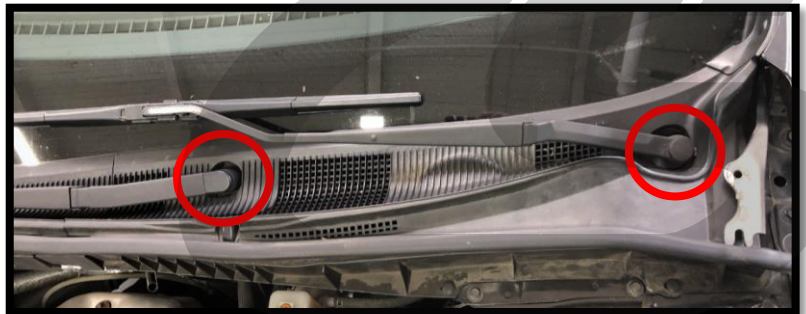

Figure 1b

DETAILED INSTRUCTIONS:

1. Removing OEM Hood and Cowl (cont.)

- h) Remove the five push clips that hold the plastic portion of the cowl to the vehicle. Shown **circled in red** in **Figure 1c**. Please note: there is a push clip behind the rectangular plastic cover in the center of the cowl. Typically, this clip can be released without removing the cover. If the cover must be removed, use care to not break the plastic as it can be fragile.



Figure 1c

- i) Disconnect the windshield washer fluid line at the left side of the cowl. Pull the hose sections apart at the joint **shown in blue** in **Figure 1c**. Also shown in **blue** in **Figure 1d**. Secure the line coming from the fender so it does not fall down into the fender.



Figure 1d

- j) Then, remove the plastic portion of the cowl from the vehicle.

DETAILED INSTRUCTIONS:

1. Removing OEM Hood and Cowl (cont.)

- k) Remove the two 10mm bolts that connect the wiper motor assembly to the metal portion of the cowl. Bolt locations **circled in red** in **Figure 1e**.
- l) Unplug the wiper motor assembly. The plug is **circled in blue** in **Figure 1e**.
- m) Remove the wiper motor assembly from the vehicle.



Use extreme caution when removing the wiper motor from underneath the windshield. The edge of the windshield can chip or crack very easily so avoid contact with the windshield whenever possible.

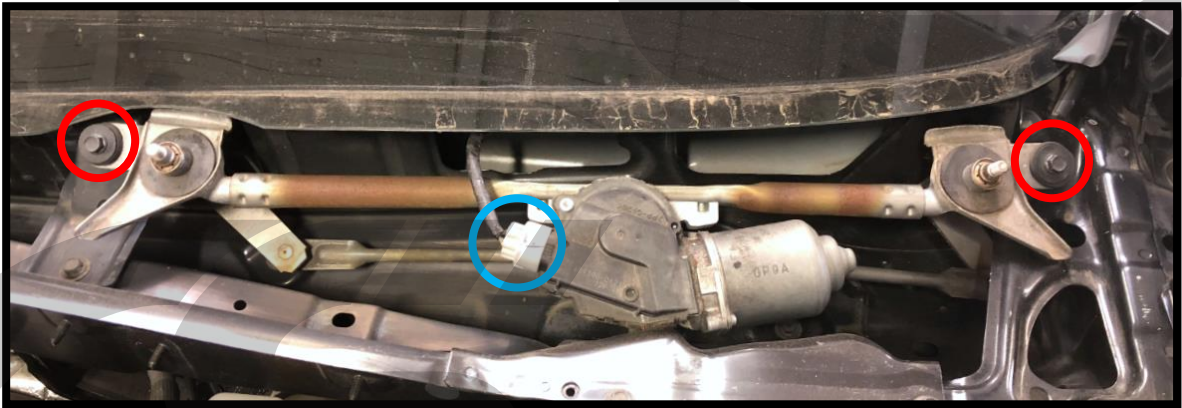

Figure 1e

- n) Remove the three 10mm bolts that attach the center cowl brace to the vehicle. **Shown in red** in **Figure 1f**. Then remove the cowl brace from the vehicle.

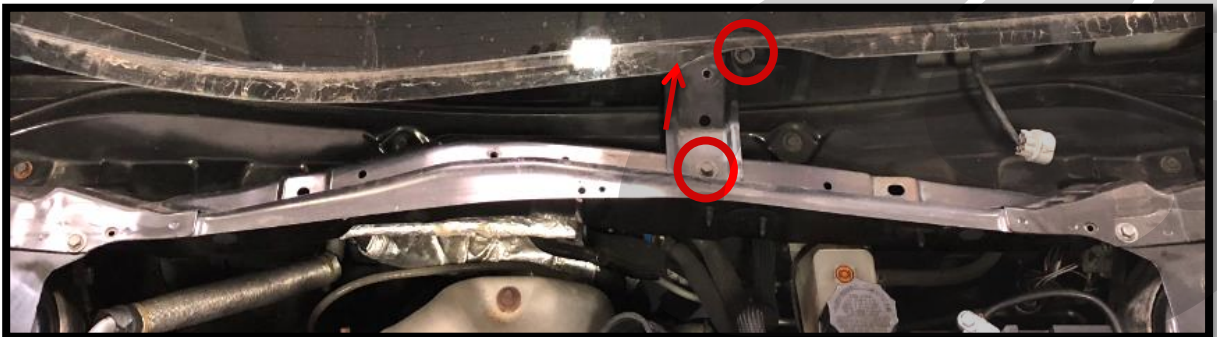

Figure 1f

DETAILED INSTRUCTIONS:

1. Removing OEM Hood and Cowl (cont.)

- o) Remove the ten 10mm bolts that hold the metal portion of the cowl to the vehicle. Bolts shown circled in red in **Figure 1g** and **Figure 1h**. Passenger side of the cowl shown in **Figure 1g**, driver side in **Figure 1h**.

- p) Remove the metal portion of the cowl from the vehicle.

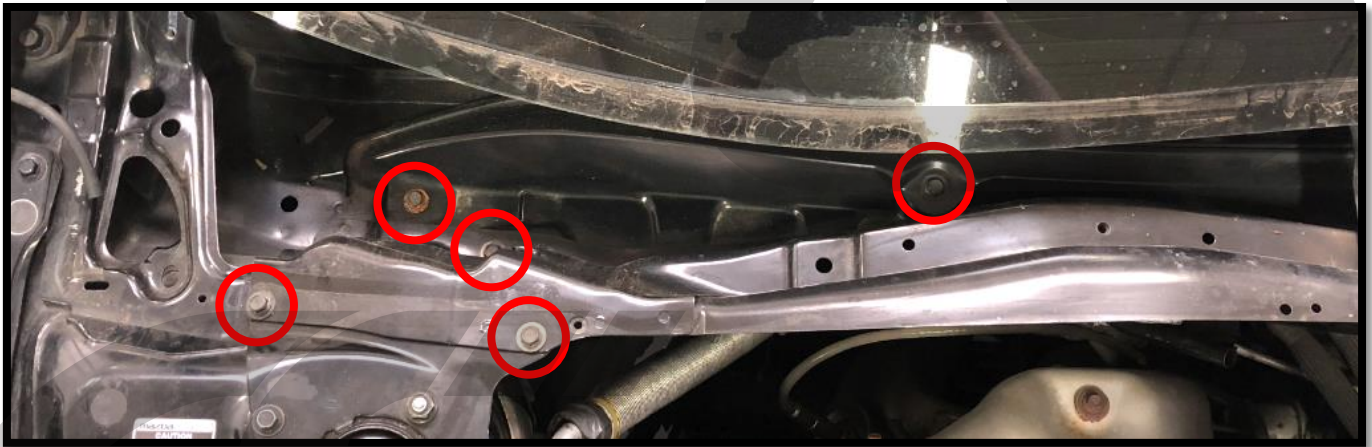

Figure 1g

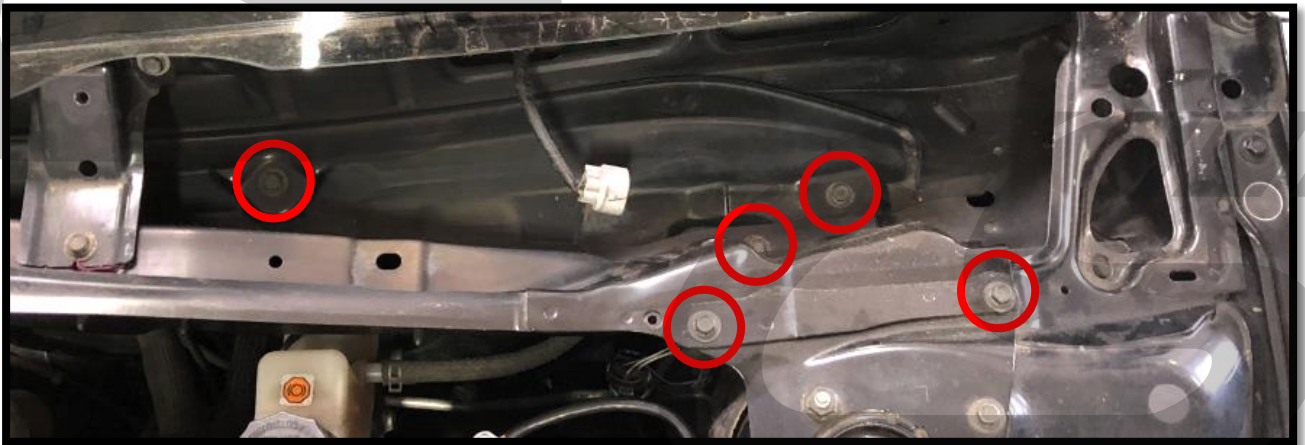

Figure 1h

DETAILED INSTRUCTIONS:

2. Removing the OEM TMIC

NOTE

The vehicle shown had a CorkSport upgraded TMIC. Disassembly is identical.

- a) Remove the two 10mm bolts holding the OEM TMIC shroud. Shown circled in red in **Figure 2a**. Then remove the TMIC shroud.
- b) Loosen the clamps at the inlet and outlet of the intercooler using a 10mm deep socket and ratchet. Clamps shown with **red arrows** in **Figure 2b**.
- c) Remove the three 12mm nuts that bolt the TMIC to the engine. Shown with **blue** in **Figure 2b**.
- d) Remove the BPV hose from your BPV. Shown with blue hose and **green arrow** in **Figure 2b**.
- e) Loosen the BPV recirc hose clamp. Depending on your setup, you may need to use pliers for an OEM spring clamp, or a 10mm socket for an aftermarket clamp. Location shown with **yellow arrow** in **Figure 2b**.
- f) Pull the TMIC free from the BPV recirc hose and remove the OEM TMIC from the vehicle.

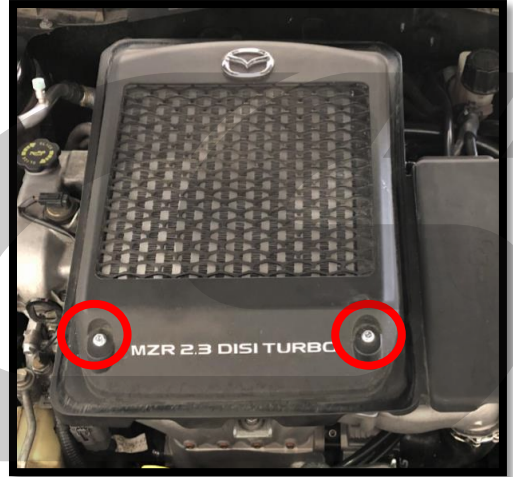

Figure 2a

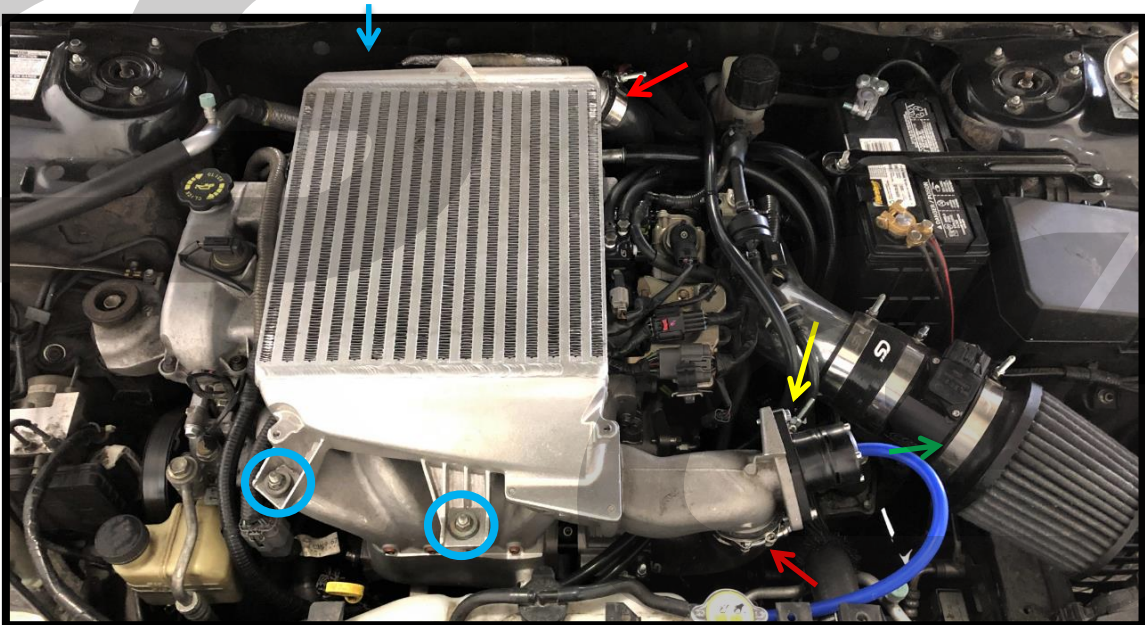

Figure 2b

DETAILED INSTRUCTIONS:

3. Removing the OEM Intake



Removal is shown with OEM components. Your setup may be different depending on modifications however the order of operations is the same.



If replacing an existing aftermarket downpipe with the CorkSport downpipe, you typically will not need to remove the intake, battery, or manifold for removal. Install will be much easier and faster if you skip the corresponding sections of these instructions



Intake & turbo inlet pipe removal is optional but we recommend removing for easier access to the manifold bolts later on.

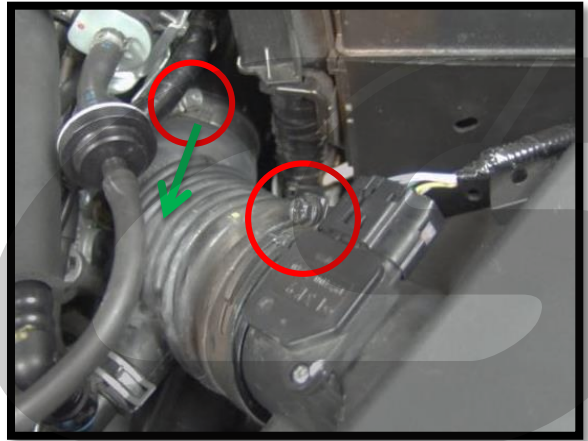

Figure 3a

a) Loosen the two (2) 10mm hose clamps on the factory rubber intake elbow (red circles in Figure 3a).

b) Pull the OEM intake elbow off the OEM turbo inlet pipe. Pull in direction shown with green arrow in Figure 3a.



Figure 3b

c) Unplug the MAF sensor located on the air filter housing (green circle in Figure 3b).

DETAILED INSTRUCTIONS:

3. Removing the OEM Intake (continued)

- f) **Remove the valve cover breather tube.** Push the hose connector toward the valve cover and press both sides of the colored clip simultaneously. Pull the hose away from the valve cover (**Figure 3c**). Some models may just have a basic hose instead of the clip shown.
- g) **Pull up on the filter housing** to pop it free from the car and remove it along with the intake elbow and breather tube.

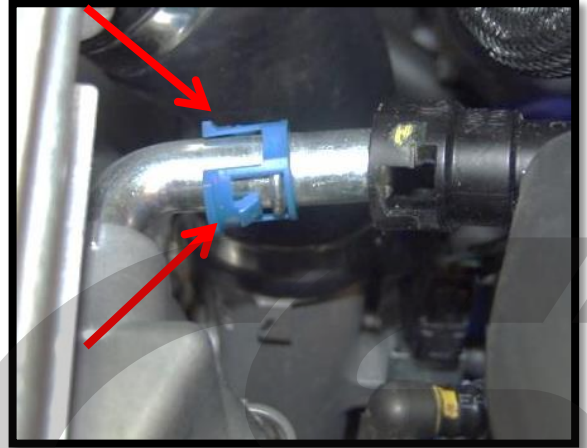

Figure 3c

4. Removing the OEM Battery & Tray

- a) **Locate your battery in the rear right of the engine bay and disconnect the battery terminals with a 10mm wrench.** Disconnect negative first, shown **circled in blue** in **Figure 4a**, then disconnect the positive, shown **circled in red** in **Figure 4a**. Move the terminals out of the way.



Aftermarket battery terminals may require a different wrench size.

- b) **Remove the 10mm nut and 10mm bolt from the battery tie down bracket.** Shown **circled in green** in **Figure 4a**. Remove the OEM tie down bracket and long "J" shaped bolt.
- c) **Remove the OEM battery from the vehicle.**

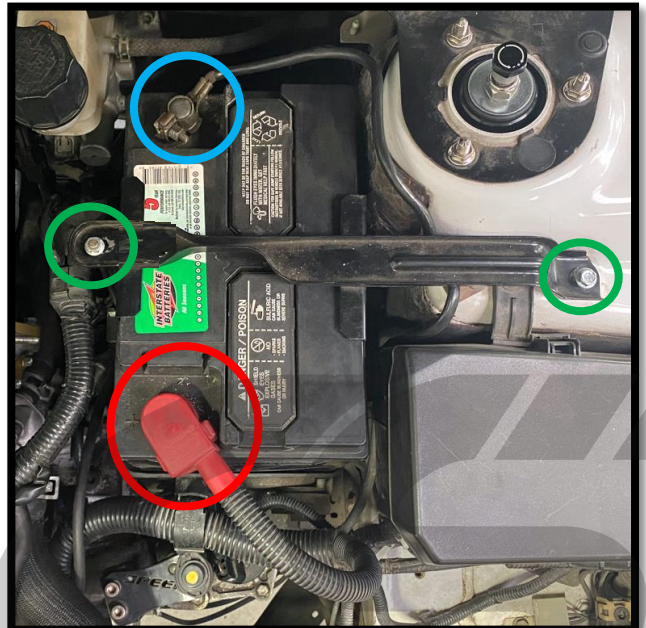

Figure 4a

DETAILED INSTRUCTIONS:

4. Removing the OEM Battery & Tray (continued)

- d) Free the wiring harness clip from the front of your battery tray with a flathead screwdriver. Pry with a flathead screwdriver like shown in **Figure 4b**.



Figure 4b

- e) Remove the two 10mm bolts from the bottom of your battery tray. Shown **circled in red** in **Figure 4c**. Lift the wiring harness free from the clip released earlier, then remove your OEM battery tray from the vehicle



Figure 4c

DETAILED INSTRUCTIONS:

5. Removing the OEM Turbo Inlet Pipe

- a. Remove the 10mm nut that holds the TIP to the engine. Location shown **circled in red** in **Figure 5a**.
 - b. Remove the two wiring harness clips . Squeeze the back side with needle nose pliers to remove. **Circled in blue** in **Figure 5a**.
- !** Be very careful not to break the plastic barb in the next step.
- c. Remove the hose from the plastic barb near the turbocharger. Use needle nose pliers to release the clamp, then pull straight up to disconnect the hose. Plastic barb shown **circled in green** in **Figure 5a**.



Figure 5a

- d. Loosen the clamp that connects the TIP to the turbocharger using a 10mm socket and extension. Location shown in **Figure 5a** with **purple arrow**.
- e. Pull the TIP off of the turbocharger , then remove the TIP from the vehicle. The BPV recirc hose will remain attached to the TIP and be removed with it.

DETAILED INSTRUCTIONS:

6. Removing the OEM Heatshields

a) Remove the six 8mm bolts circled in red in **Figure 6a**, then remove the upper manifold heat shield.

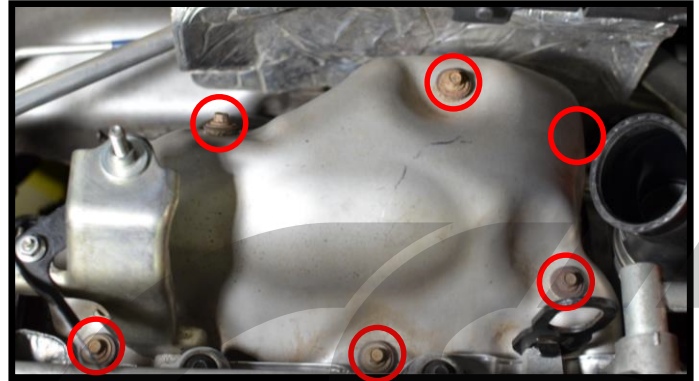

Figure 6a

c) Remove the three 8mm bolts holding the lower manifold heat shield shown with the red circles in **Figure 6b**. Then remove the heatshield.

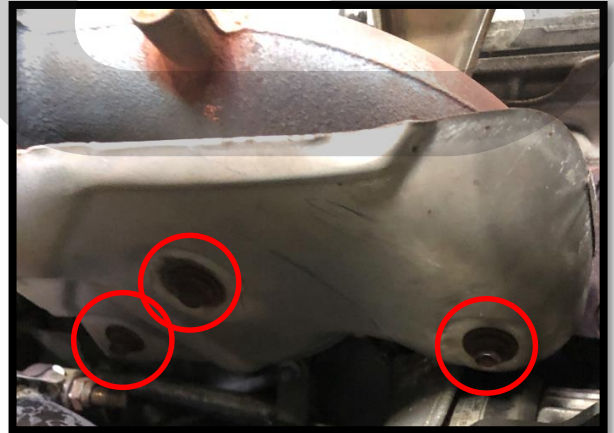

Figure 6b

d) Remove the three 8mm bolts from the turbine housing heat shield. Shown in red in **Figure 6c**. Note, the bolt shown with the arrow is on the underside of the turbo and is difficult to see from the top side.

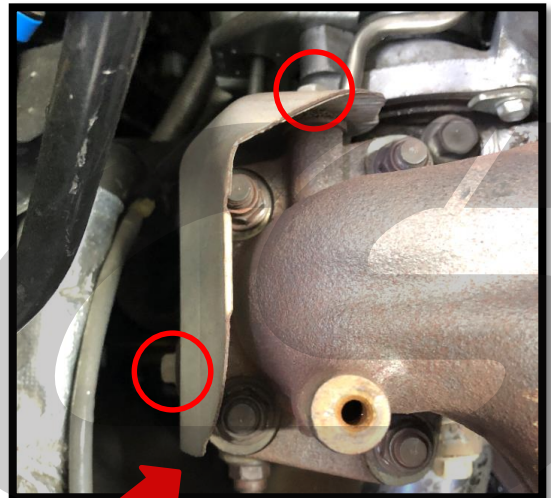

Figure 6c

DETAILED INSTRUCTIONS:

7. Removing the OEM Exhaust Manifold



You can remove the OEM downpipe without removing the exhaust manifold, however it is difficult and typically damages components on its way out. So we strongly recommend manifold removal for easiest OEM DP removal.

- a) Remove the 8mm bolt that secures the oil feed line to the OEM manifold. **Circled in red in Figure 7a.** It is located below the cylinder 2 runner, near the downpipe O2 sensor.
- b) Remove the four 14mm nuts that attach the OEM exhaust manifold to the turbocharger. **Circled in red in Figure 7b.**
- c) Remove the OEM lifting eye and rear TMIC mount by removing the three 14mm bolts **shown in red in Figure 7c.** If your vehicle has wiring clipped to the TMIC mount, you will need to unclip this wiring.
- d) Remove the ten 14mm nuts that attach the OEM manifold to the engine. Shown numbered in **Figure 7d.** Order does not matter during removal. Then remove the OEM exhaust manifold from the vehicle.



Figure 7a

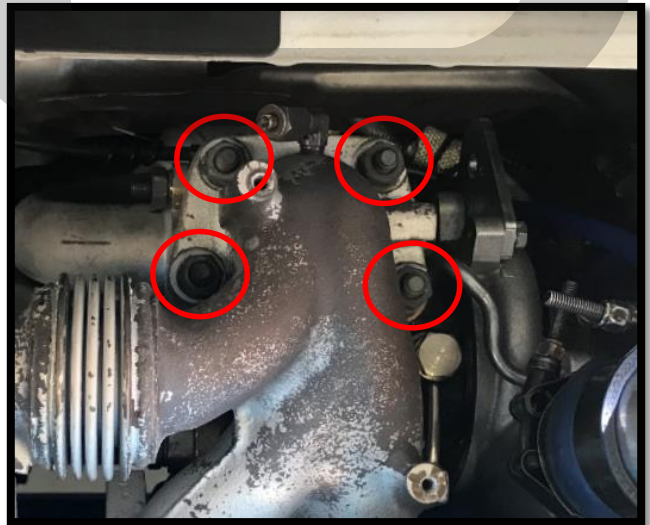

Figure 7b

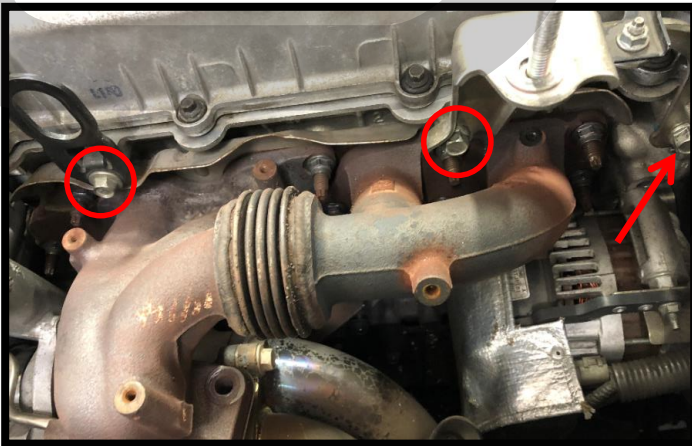

Figure 7c

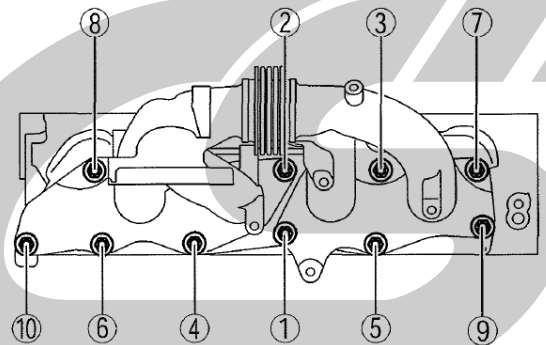
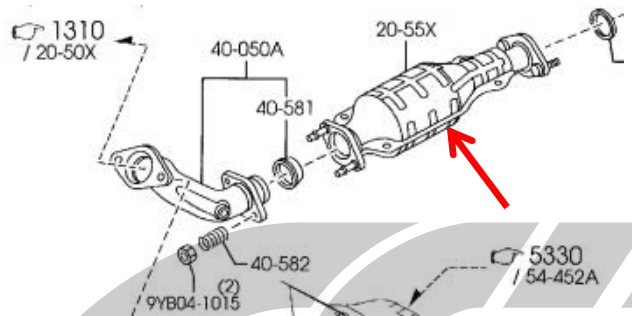

Figure 7d

DETAILED INSTRUCTIONS:**8. Removing the OEM Downpipe Lower Sections**

a) Move underneath the car and locate the secondary catalytic converter section. Shown with **red arrow** in **Figure 8a**. This is the section right before the long midpipe section.

**Figure 8a**

b) Remove the two 17mm nuts that connect the secondary cat to the midpipe. Shown with **red arrows** in **Figure 8b**.

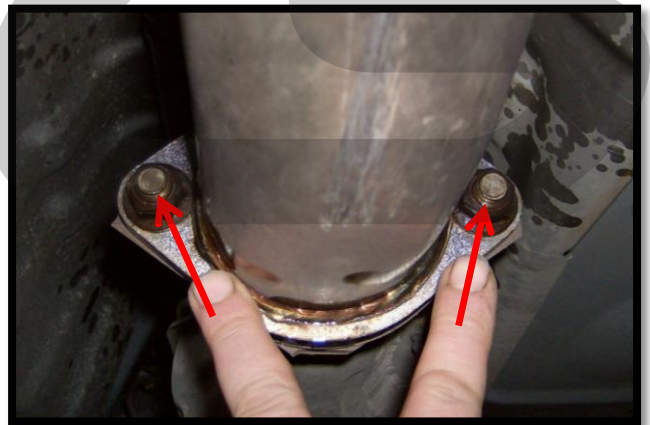
**Figure 8b**

c) Remove the two 14mm nuts that connect the secondary cat to the downpipe. Shown with **red arrows** in **Figure 8c**. Then remove the secondary cat section from the vehicle.

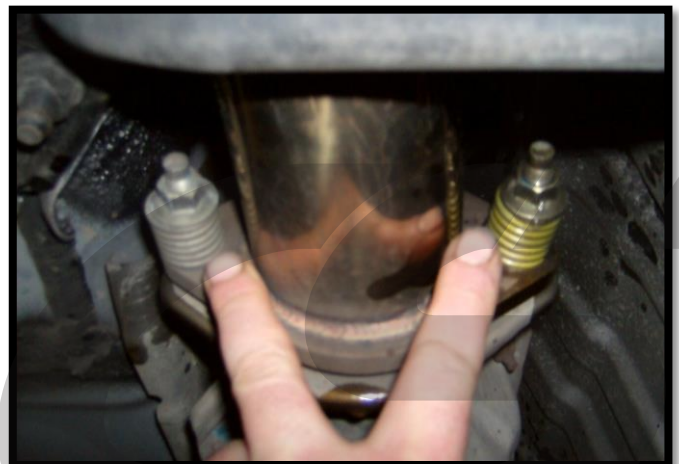
**Figure 8c**

DETAILED INSTRUCTIONS:**8. Removing the OEM Downpipe Lower Sections (continued)**

- a) Move underneath the car and locate the lower downpipe section. Shown with **red arrow** in **Figure 8d**. This section was connected to the cat removed in the previous step.
- b) Trace the secondary O2 sensor wiring up to the plug on top of the transmission. Unplug this gray connector. Wiring shown in **Figure 8e**. Remove any wiring clips present so the O2 sensor can be removed with the lower downpipe section.
- c) Remove the two 14mm nuts connecting the lower downpipe section to the upper downpipe section. Nuts shown with **red arrows** in **Figure 8f**. Then remove the lower downpipe section from the vehicle.

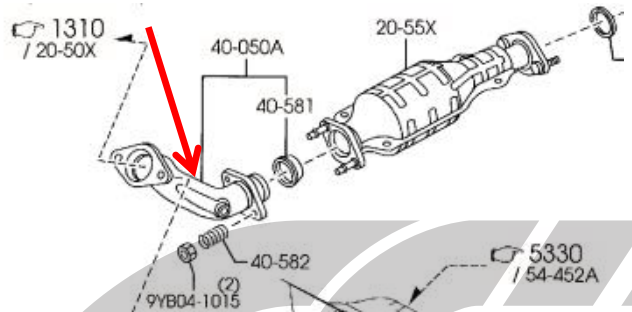
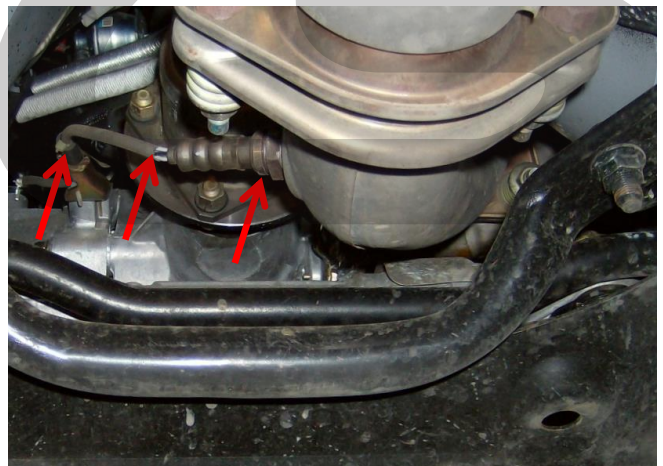
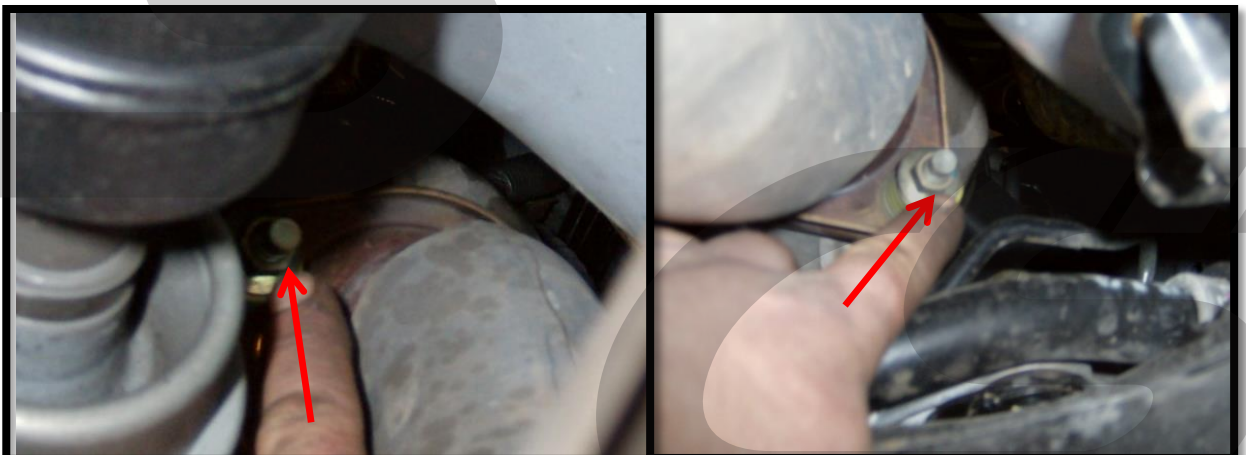
**Figure 8d****Figure 8e****Figure 8f**

DETAILED INSTRUCTIONS:**9. Removing the OEM Downpipe Upper Section**

- a) While still underneath the car, locate the upper downpipe support bracket. Shown with **red arrow** in **Figure 9a**.
- b) Remove the four 14mm bolts that attach the bracket to the downpipe & engine, then remove the bracket from the vehicle. Bolts shown with **blue circles** in **Figure 9a**. Two bolts shown already removed.
- c) Using a penetrant spray, spray around the base of the O2 sensor where it meets the OEM downpipe. Let the fluid soak for several minutes. Then remove the O2 sensor from the DP using an O2 sensor socket. O2 sensor shown with **red arrow** in **Figure 9b**. Free the O2 wiring from the downpipe and set the O2 sensor aside. No need to unplug it.
- d) Remove the three 10mm bolts holding the upper downpipe heatshield to the downpipe. Shown with **blue markings** in **Figure 9b**. Then remove the upper downpipe heatshield.

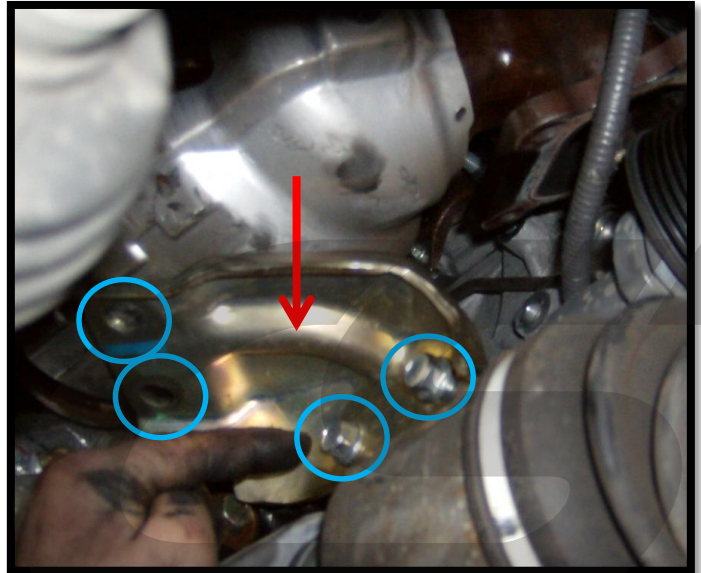
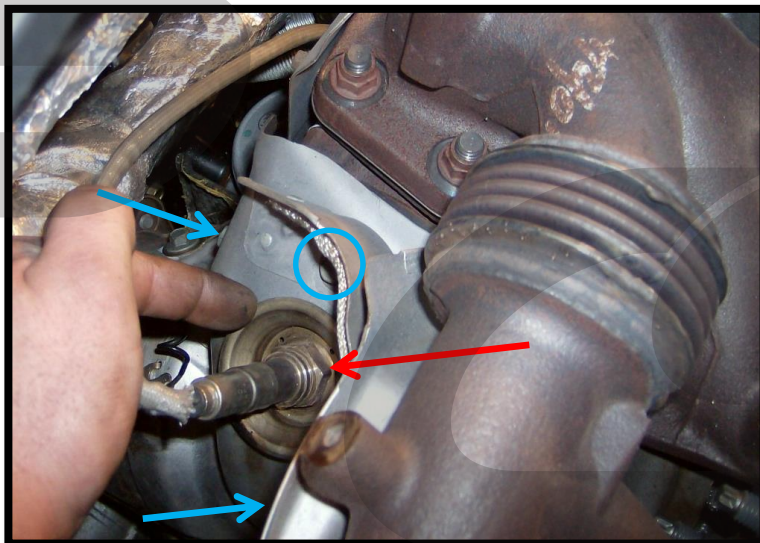
**Figure 9a****Figure 9b**

DETAILED INSTRUCTIONS:

9. Removing the OEM Downpipe Upper Section (continued)

- e) Using a penetrant spray, spray the five OEM downpipe mounting studs/nuts. Let the fluid soak for several minutes, then remove the downpipe mounting nuts using a 14mm socket and ratchet. Shown with red markings in Figure 9c.
- f) The upper downpipe section can then be removed from the vehicle. It can be removed out the top of the engine bay, through the space made by removing the exhaust manifold & cowling.

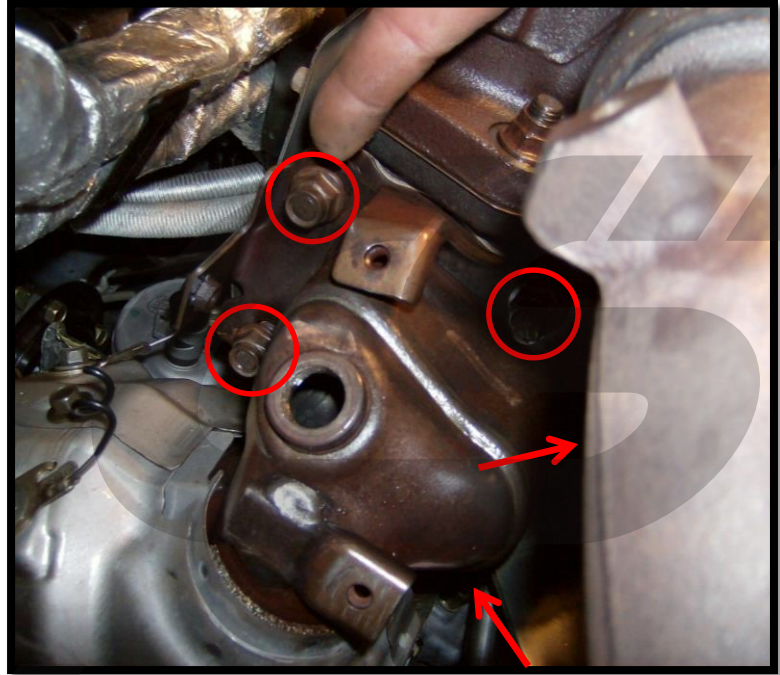

Figure 8a

10. Installing the CorkSport Downpipe - Pre-Install Notes

- NOTE** Included in your downpipe kit are replacement downpipe mounting studs and nuts. We recommend replacing all old studs/nuts with the included ones, however, if in good condition, the old hardware can be reused.
- NOTE** The provided studs and nuts are M10x1.5 threads, verify your turbo matches thread size & pitch.
- NOTE** If you are using an external wastegate (EWG) on a CorkSport turbo with EWG housing, remove the EWG, dump tube, and the EWG mounting elbow. Later in the instructions shows the new orientation of the EWG and elbow. A new dump tube will be required to correctly fit this downpipe. Available on the CS website.
- NOTE** If you are using an external wastegate (EWG) on a CorkSport exhaust manifold with CS dump tube, remove the EWG and the dump tube. A new dump tube upper section will be required to correctly fit this downpipe. Later in the instructions discusses how to install the new dump tube with CS manifold.

DETAILED INSTRUCTIONS:

10. Installing the CorkSport Downpipe

- a) Install the supplied turbocharger gasket onto the studs of your turbocharger. Gasket shown in **Figure 10a**. It will only install in one orientation.

- b) Install the CS downpipe bellmouth. Slide it over the turbocharger studs and secure with the five supplied nuts. Shown with red markings in **Figure 10b**.

- c) Tighten all downpipe bellmouth mounting nuts to **39-46ft-lbs**.



Figure 10a

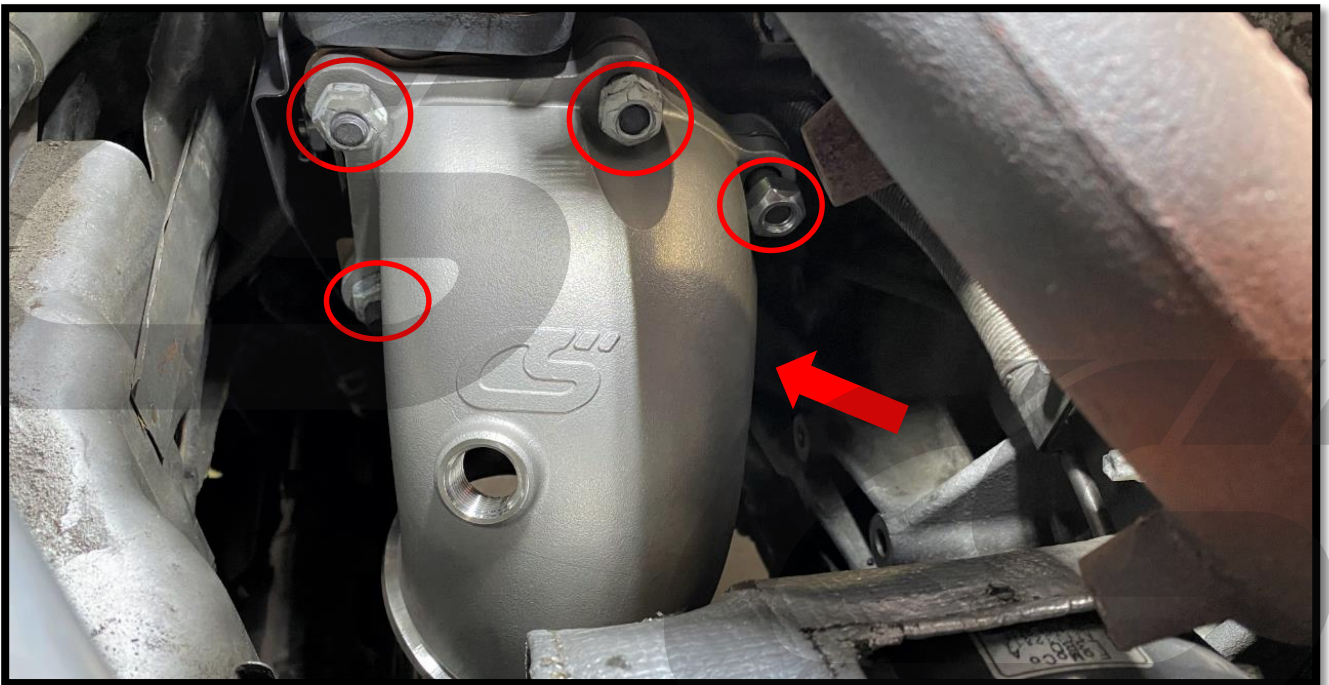

Figure 10b

DETAILED INSTRUCTIONS:

10. Installing the CorkSport Downpipe (continued)

- d) Lift the CS downpipe into the vehicle from the bottom until it is positioned approximately as shown in **Figure 10c**. The v-band end will end up close to the end of the bellmouth installed earlier



Figure 10c

- e) Secure the downpipe to the midpipe using the supplied gasket and hardware. Keep the bolts very loose to allow for plenty of movement, they will be tightened later. Use the hardware stack as shown in **Figure 10d**, with flat washers against the flanges and the lock washer against the nut.



This will hold the downpipe roughly in place while the v-band is connected.

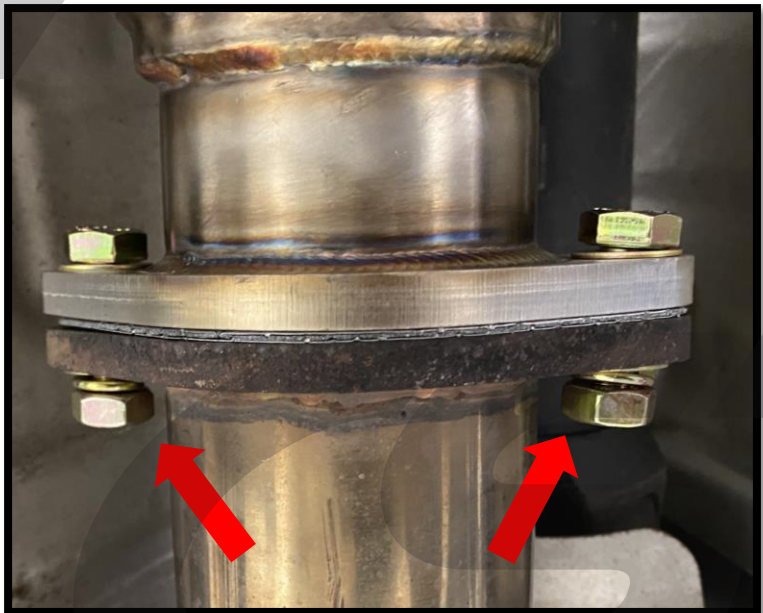

Figure 10d

DETAILED INSTRUCTIONS:

10. Installing the CorkSport Downpipe (continued)

- f) Place the supplied v-band clamp over the end of the downpipe in the orientation shown in **Figure 10e**. The nut should point towards the alternator.



Attaching the v-band clamp in the next few steps can be difficult. For easiest install, have a friend under the car to hold the downpipe up while you secure the clamp from the top.

- g) Hold the downpipe upwards against the bellmouth, and align the flanges as shown in **Figure 10f**.

- h) While holding the downpipe securely against the bellmouth, tighten the v-band clamp around the flanges as shown in **Figure 10e**. Tighten the clamp with a 10mm wrench just enough to hold the downpipe in position. It will be fully tightened later.



Failure to properly line up the V-band flanges will result in exhaust leaks.

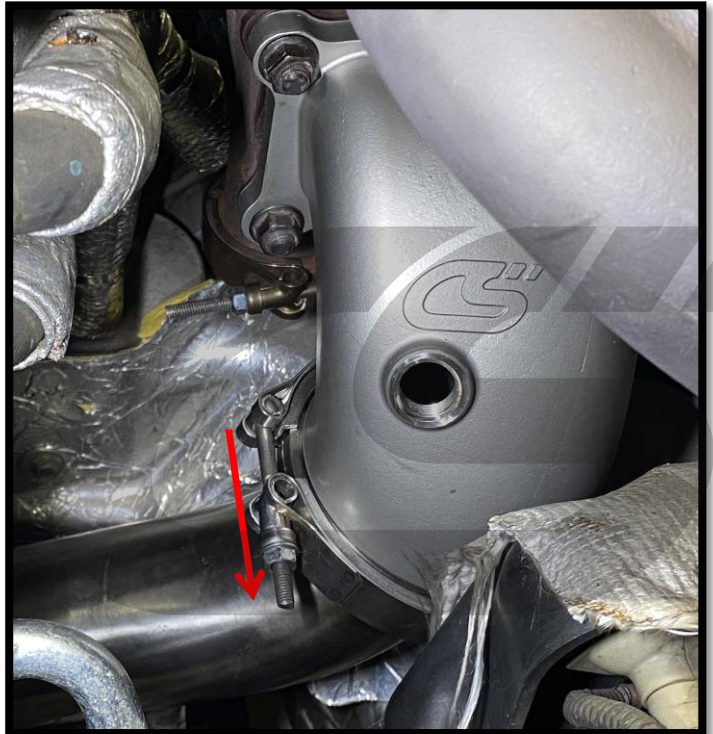

Figure 10e



Figure 10f

DETAILED INSTRUCTIONS:

10. Installing the CorkSport Downpipe (continued)

i) Secure the flange that connects the downpipe to the midpipe. Center the flanges on one another and tighten the two 17mm bolts/nuts to **45ft-lbs**. Hardware shown tightened in **Figure 10g**.

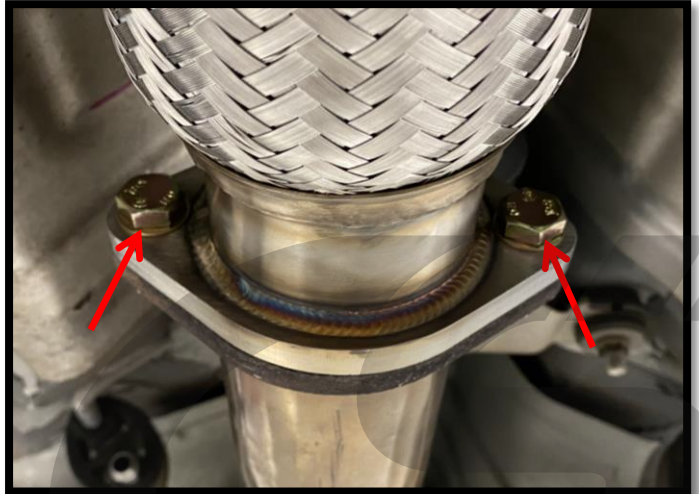

Figure 10g

j) Attempt to wiggle/rotate the downpipe near the bellmouth to help the v-band connection settle into position.

k) Once happy with fitment, tighten the v-band clamp to **8-12ft-lbs** with a 10mm deep socket & ratchet. Shown tightened in **Figure 10h**.

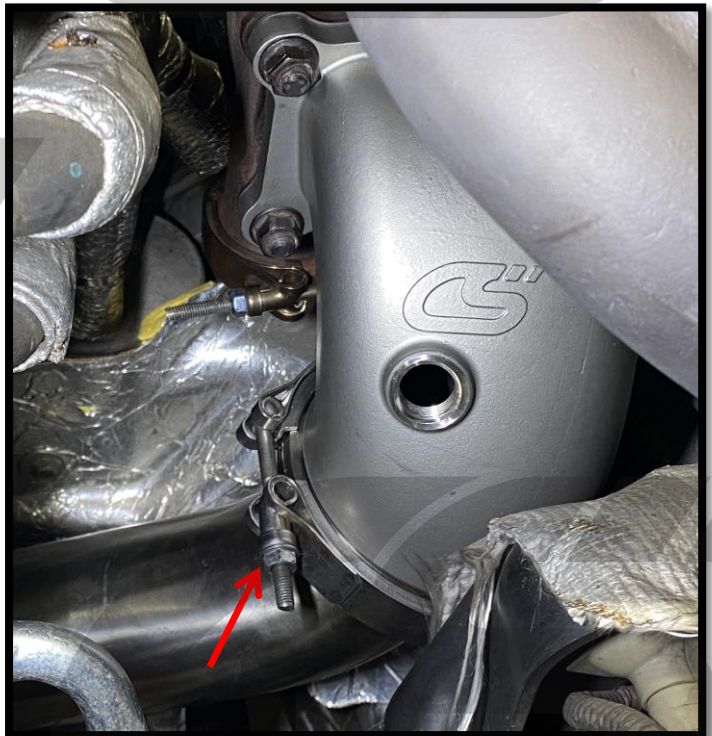

Figure 10h

DETAILED INSTRUCTIONS:

10. Installing the CorkSport Downpipe (continued)

- l) **CATTED DOWNPIPE ONLY:** Install the supplied O2 sensor extension harness into the lower O2 sensor wiring. Where the gray plug was unplugged in Step 8b.
- m) Remove the lower O2 sensor from the OEM lower downpipe section using an O2 sensor socket.
- n) Install the provided O2 sensor defouler into the lower port of the downpipe.
- o) Install the lower O2 sensor into the defouler lower port of the CS downpipe. Use a small amount of anti-seize on the threads and tighten using an O2 sensor socket. Do not over tighten the sensor, approximately ¼-½ turn past hand tight is plenty.
- p) Plug in the lower O2 sensor into the OEM wiring harness or the CS O2 extension harness (catted DP only). Ensure the wires are secured away from heat and so they will not drag on the ground.

11. EWG & Dump Tube Setup



If running a stock turbo or turbo with internal wastegate please skip to Section 12 on Page 26. If running a different aftermarket EWG setup (not CorkSport), install your EWG setup now. You may need a different setup to work with the new downpipe. If running a CorkSport exhaust manifold with the EWG on the manifold, skip to Step 11g on Page 25.

- a) The following steps are for a CorkSport turbo with EWG coming off the turbine housing.
- b) Begin by installing the EWG elbow supplied with your CS EWG turbine housing in the orientation shown in **Figure 11a**. Secure with the clamp that came with your EWG housing but leave the clamp loose enough to let the elbow rotate.

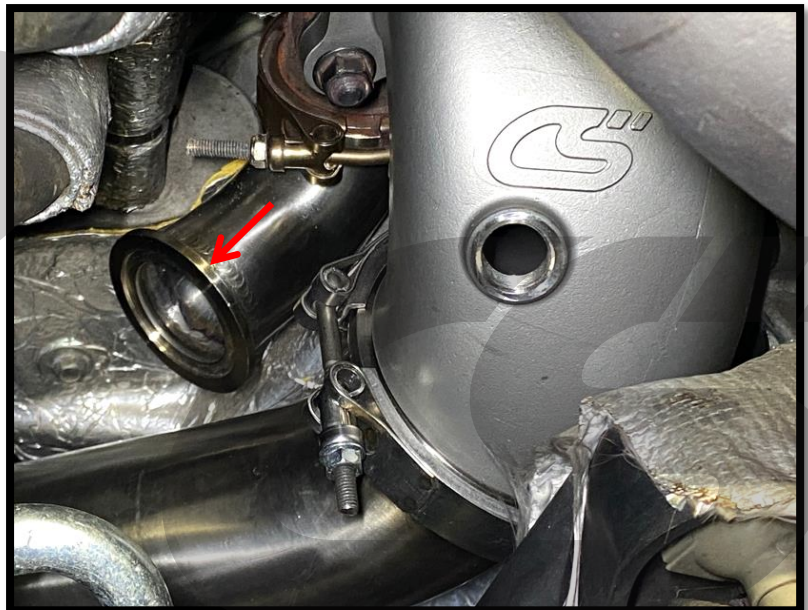

Figure 11a

DETAILED INSTRUCTIONS:

11. EWG & Dump Tube Setup (continued)

- c) Install your EWG onto the end of the EWG elbow in the approximate orientation shown in **Figure 11b**. Secure with the large clamp that came with your EWG but leave the clamp loose enough to let the elbow rotate. **Do not forget the fire ring/valve seat in your EWG!**

- d) Install your dump tube onto the end of the wastegate in the orientation shown in **Figure 11c**. Secure with the small clamp that came with your EWG but leave the clamp loose enough to let the elbow rotate. Then dump should end up pointing below your subframe as shown in **Figure 11d**.



Dump tube required to work with this setup is CorkSport Part Number **GEN-6-575-17**.

- e) Check that all components are clear and will not rub on anything. Adjust as needed by rotating the different flanges. Once happy with fitment, tighten the three v-band clamps to **8-12ft-lbs**.

- f) Connect all boost reference lines needed for your EWG setup and ensure they are safe from heat.

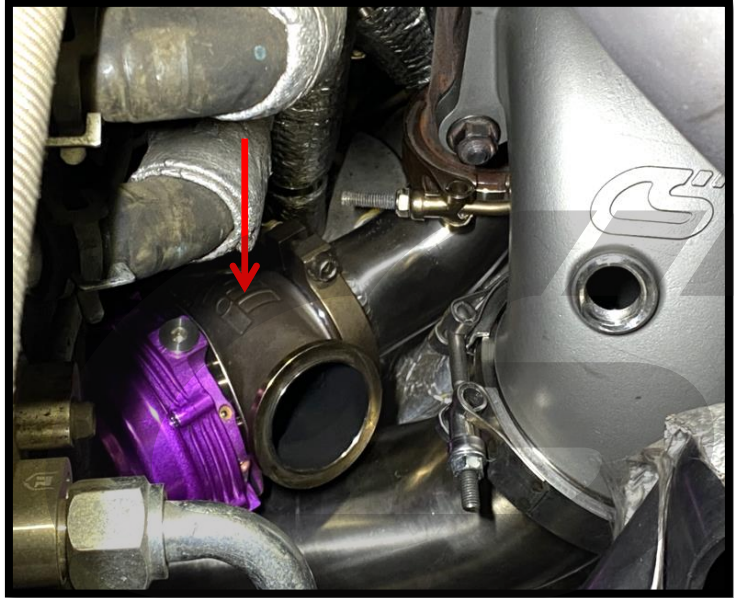

Figure 11b

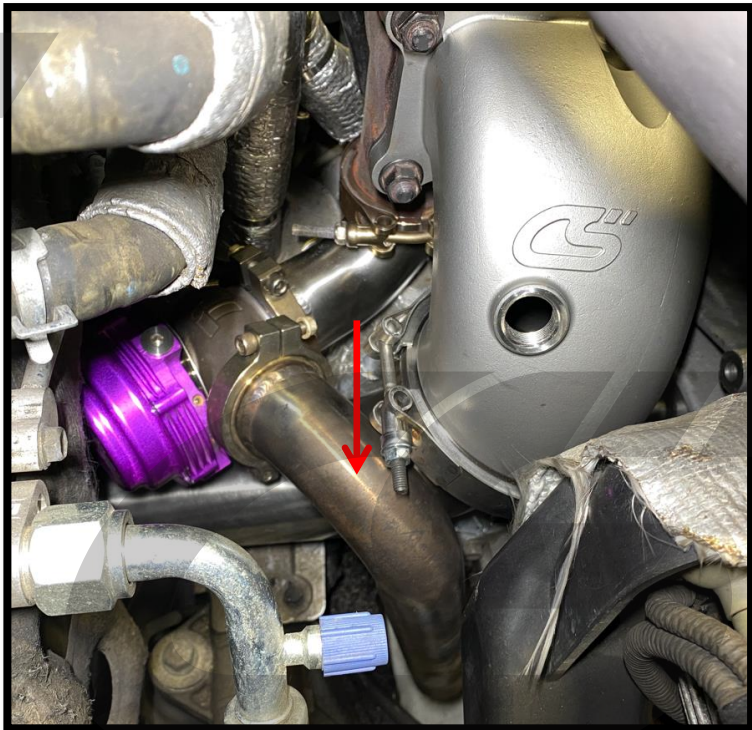

Figure 11c



Figure 11d

DETAILED INSTRUCTIONS:

11. EWG & Dump Tube Setup (continued)

- g) The following steps are for a CorkSport exhaust manifold with EWG coming off the manifold. Skip to Section 12 on Page 26 if you just put an EWG coming off your turbo.

 To make the CS exhaust manifold EWG location work, a new upper section of the EWG dump is required. This is CS part number **AXL-6-442-31-V3**. The normal lower dump tube and existing clamp are reused. For more detailed instructions for setting up an EWG on the manifold, see the exhaust manifold install instructions.

- h) **Install your EWG onto the exhaust manifold port if it was removed previously.** Secure with the large clamp that came with your EWG but leave it loose to allow for rotation.
- i) **Install the new upper EWG dump tube onto the end of the EWG.** It will feed down thru the center of the manifold like the old dumptube. Secure with the small clamp that came with your EWG but leave it loose to allow for rotation.
- j) **Install the existing lower EWG dump tube into the upper tube.** The longer end of the lower tube will slide into the upper tube. Install the existing EWG dump clamp over the joint.

 Fitment with CS manifold and EWG dump is extremely tight. Take your time when adjusting the dump to ensure no points of contact with components. There is a narrow range of adjustment where everything will fit. Pictures do not show this process well due to how tight everything is.

- k) **Adjust all components until nothing is hitting.** Once happy with fitment, tighten the two V-band clamps to **8-12ft-lbs** and the dump tube clamp to **32-40ft-lbs**.
- l) **Connect all boost reference lines needed for your EWG setup and ensure they are safe from heat.**

DETAILED INSTRUCTIONS:

12. Vehicle Reassembly and First Startup

- a) **Install your primary O2 sensor into the port on the CS bellmouth.** Use a small amount of anti-seize on the threads and tighten using an O2 sensor socket. Do not over tighten the sensor, approximately 1/4-1/2 turn past hand tight is plenty. Secure the wiring away from heat and ensure it cannot fall onto hot exhaust.
- b) **Follow the instructions in reverse order to complete the vehicle assembly. Refer to torque specs below.**
1. **Reinstall the OEM exhaust manifold.** Tighten bolts in the order shown in Figure 7d. Tighten to **32-47ft-lbs.**
 2. **Reinstall the heatshields.** The upper downpipe heatshield will not be reused.
 3. **Reinstall the turbo inlet pipe.**
 4. **Reinstall the battery tray & battery.**
 5. **Reinstall the intake.**
 6. **Reinstall the TMIC**
 7. **Reinstall the cowl & hood**
- c) **Torque Specs:**
- 8mm Nut/Bolt 8-10 ft-lbs
 - 10mm Nut/Bolt 15-17 ft-lbs
 - 12mm Nut/Bolt 19-21 ft-lbs
 - 14mm Nut/Bolt 30-32 ft-lbs



Before starting the vehicle, we recommend double checking all components that could have been affected during the manifold removal & downpipe swap. Including boost reference lines.



We strongly recommend getting a retune to ensure safe engine operation with your new downpipe.

- c) **Start the vehicle.** During first startup, listen for any strange noises, that may indicate an exhaust leak or other abnormalities that may indicate something was installed incorrectly. On rare occasions, the bellmouth will need to be loosened from the turbocharger & shifted slightly to ensure a good seal at the v-band connection.



Smoke coming off the downpipe and/or manifold during first start is normal. This is machining oil and oils from your hands burning off of the downpipe & manifold as they heat up for the first time. It will go away after a short while.



This completes the installation of your CorkSport Downpipe. Listen for any strange noises during the first few drives. We also recommend a double checking V-band tightness after a few weeks of driving. Enjoy the added performance and great new sound!

WHAT'S NEXT?

CorkSport CST5 Turbocharger

Not too big, not too small. ITS JUST RIGHT for YOUR SPEED. Capable of built block power and extremely fast spool times, this turbo can make 500+whp and hit 20psi by 3500-3600rpm. The CorkSport CST5 turbo can be tuned for a more laid-back curve that is stock block safe or pushed to 30+psi for built blocks and auxiliary fueling. No matter what build you have this turbo will be sure to impress. The CST5 features a MHI Journal Bearing CHRA, 0.82 Turbine A/R and 4" Anti-Surge Compressor Cover. The CST5 turbo is available in two boost control setups: Internally Wastegated (IWG) & 44mm Externally Wastegated (EWG) w/included EWG elbow pipe & V-band clamp.



CorkSport Exhaust Manifold

Performance, Reliability, and Sound for your build...this is the exhaust manifold for your Mazdaspeed. You are looking at the only performance exhaust manifold that can fit 3 different turbo flange options: Stock Mazda Flange, T3 Flange, Precision V-Band and Tial V-Band. This modular design allows you to choose your flange style and change it later without replacing the entire manifold. Cast from 304SS, there are no welded flanges or connections that are prone to cracking and each flange surface is precision machined for flatness. Whether you are stock turbo or looking for the most powerful stock flange turbo, the CST6, this manifold supported 685 Whp with ease and don't forget the specifically designed dumptube that makes life easy for you.

